

Operating instructions

AdoraDish V2000

Dishwasher

Thank you for choosing to buy one of our products. Your appliance is made to high standards and is easy to use. Nevertheless, please take the time to read these operating instructions in order to familiarize yourself with the appliance and get the best use out of it.

Please follow the safety precautions.

Modifications

Text, diagrams and data correspond to the technical standard of the appliance at the time these operating instructions went to press. The right to make technical modifications for the purpose of the further development of the appliances is reserved.

Validity

The model number corresponds to the first alphanumeric on the identification plate. These operating instructions apply to:

Model designation	Type	Size system
AdoraDish V2000	AS2T-41091	SMS 55
AdoraDish V2000	AS2T-41093	SMS 55
AdoraDish V2000	AS2T-41094	SMS 55
AdoraDish V2000	AS2T-41106	EURO 60
AdoraDish V2000	AS2T-41107	EURO 60
AdoraDish V2000	AS2T-41108	EURO 60
AdoraDish V2000	AS2T-41109	EURO 60

Variations depending on the model are noted in the text.

Contents

1	Safety warnings	4	7.7	Wipe protection	33
1.1	Symbols used.....	4	7.8	Information	33
1.3	General safety precautions.....	4	8	V-ZUG-Home	34
1.4	Appliance-specific safety precautions	5	8.1	Conditions	34
1.5	Instructions for use.....	6	8.2	Initial set-up.....	34
2	Using for the first time	8	9	User settings	35
2.1	Before using for the first time.....	8	9.1	Changing the user settings.....	35
2.2	Setting the door weight	8	9.2	Overview of user settings.....	35
3	Appliance description	9	10	Care and maintenance	38
3.1	Construction	9	10.1	Cleaning the interior and exterior	38
3.2	Operating and display elements.....	10	10.2	Cleaning the spray arms	38
3.3	FunctionLight *	11	10.3	Cleaning the filter system.....	39
4	Functions	13	10.4	Refilling with regeneration salt	39
4.1	Programmes.....	13	10.5	Filling with rinse agent.....	40
4.2	Setting options	14	11	Trouble-shooting	41
4.3	Frequently used user settings.....	15	11.1	Error messages.....	41
5	Loading	16	11.2	Other possible problems.....	43
5.1	Preparing the appliance	16	11.3	Unsatisfactory washing results.....	44
5.2	Loading tips for the lower basket.....	16	11.4	In the event of a power failure	45
5.3	Loading tips for the upper basket.....	18	12	Accessories and spare parts	45
6	Operation	21	12.1	Accessories	45
6.1	Dish washing tips	21	12.2	Spare parts	46
6.2	Selecting detergent	22	13	Technical data	46
6.3	Adding the detergent	23	13.1	Safety concept	46
6.4	Operating the display.....	24	13.2	Overflow protection	46
6.5	Selecting and starting a programme	25	13.3	Product fiche	47
6.6	Adding extra dishes	26	13.4	Note for testing institutes	47
6.7	Aborting a programme before time	26	13.5	Noise measurement.....	47
6.8	Unloading dishes.....	27	14	Disposal	48
7	Programme options	28		Index	49
7.1	Delayed start	28	15	Service & Support	51
7.2	Programme in permanent mode	29			
7.3	Favourites.....	30			
7.4	Permanently selecting setting options.....	31			
7.5	Childproof lock.....	32			
7.6	All in 1.....	33			

1 Safety warnings

1.1 Symbols used



Denotes important safety precautions.

Failure to observe said precautions can result in injury or in damage to the appliance or fittings!



Information and precautions that should be observed.



Information on disposal



Information about the Operating Instructions



Remove plug from mains socket / disconnect power supply



Insert plug into mains socket / connect power supply



Do not cut off or modify mains plug



Wear protective gloves

- ▶ Indicates step-by-step instructions.
 - Describes how the appliance reacts to the steps taken.
- Indicates a list.

1.2 Notes on using the operating instructions

Graphical operating instructions can be downloaded on the internet from www.vzug.ch.

1.3 General safety precautions



- Read the operating instructions before using the appliance for the first time.



- This appliance can be used by children aged 8 and above and by persons with reduced physical, sensory or mental capabilities, or lack of experience and/or knowledge, provided they are supervised or have been instructed on the safe use of the appliance and have understood the hazards involved. Children shall not play with the appliance. Cleaning and user maintenance shall not be undertaken by children without supervision.
- If an appliance is not equipped with a mains cable and a plug or other means for disconnecting from the mains with a contact opening on each pole complying with the conditions of overvoltage category III for full isolation, an isolating device must be incorporated into the perman-

ently installed electrical installation in accordance with the installation regulations.

- If the mains cable of this appliance is damaged, it must be replaced by the manufacturer or its Customer Services or a similarly qualified person in order to avoid hazard.

1.4 Appliance-specific safety precautions

- Never use a steam cleaner to clean the appliance.
- If the appliance is installed on a carpeted floor ensure that the ventilation openings on the base of the appliance are not obstructed.
- Only leave the appliance door open in the at-rest position. An open appliance door poses a danger of tripping or injury. Do not sit or rest on the appliance door or use it as a storage surface.
- CAUTION: Knives and other items with sharp points must be placed with the point downwards or placed horizontally in the basket.
- CAUTION: Do not drop or insert knives, forks or other sharp items in the opening of the door lock.
- No detergent must enter the opening of the door lock. This can cause the door lock to malfunction.
- The appliance is only suitable for washing household dishes and cutlery with water and standard dishwasher detergent. The appliance is for use in the home and for the intended purpose only. No liability is assumed for any damage caused by improper or incorrect use.
- Capacity: 12 international place settings (SMS 55). 13 international place settings (EURO 60).
- This appliance is designed to be used for household and similar purposes such as: staff kitchens in shops, offices and other commercial premises; agricultural properties; by customers in hotels, motels and other residential facilities; in bed-and-breakfast hotels.

1.5 Instructions for use

Before using for the first time

- The appliance must be installed and connected to the electricity supply in accordance with the separate installation instructions. Have a qualified fitter/ electrician carry out the necessary work.



The appliance was tested with water before being shipped. There may therefore still be traces of water left in the appliance.

Correct use

- Any repairs, modifications or manipulations to the appliance, especially any electrically live parts, may only be carried out by the manufacturer, its Customer Services or a similarly qualified person. Repairs if carried out incorrectly may cause serious injury, damage to the appliance and fittings, as well as affect the functioning of the appliance. If the appliance is not working properly or in case a repair is needed, follow the instructions given in the «Service & Support» section. If required, please contact our Customer Services.
- Use original spare parts only.
- Retain these operating instructions for future reference.

Children in the home

- The water in the appliance is not to be used as drinking water. Detergent residue in the appliance could cause eye or skin irritation! Keep children away from the open appliance.

Note on use

- Use the childproof locking facility (see page 32).
- If the appliance is visibly damaged, do not use it. Contact our Customer Services.
- If the appliance is not functioning properly, disconnect it from the power supply immediately.

- Before closing the appliance door and starting a programme ensure that there are no foreign objects or pets in the appliance. Foreign objects such as nails and paper clips can damage parts of the appliance as well as the dishes.
- Only use detergent, rinse agent and regeneration salt explicitly recommended for use with dishwashers by the manufacturer in its instructions for use. Follow the corresponding instructions for use carefully.
- Do not use the appliance without any or too little detergent – risk of causing damage to the appliance!
- Do not use washing-up liquid as it can produce excessive foaming, causing your appliance to malfunction.
- After filling the salt reservoir, run the  programme without dishes.
- Never fill the rinse agent reservoir or the regeneration salt reservoir with detergent. If this were to happen, however, do not operate the appliance under any circumstances, as this could cause expensive damage to it. Call Customer Services.
- Never operate the appliance without the filter system in place.
- Only use soft materials for cleaning beneath the filter system. Never use metal objects.

Caution: Risk of burns!

- Do not wash objects that are soiled with inflammable or corrosive solvent, paint, wax, chemicals (acids or bases) or iron shavings or that can shed fibres in the appliance.
- Avoid opening the appliance door unnecessarily during operation. The dishes and water may be hot – scalding hazard! The steam that escapes could damage wooden combination fascias. Spectacles can steam up, impairing your vision.

Caution: Risk of injury!

- Do not lean on any part of the appliance – risk of accident!
- Keep pets away from the appliance.

Caution: Risk to life!

- Packaging material, e.g. plastic film and polystyrene, can be dangerous for children. Danger of suffocation! Keep packaging material away from children.
- When carrying out maintenance work on the appliance, including replacing light bulbs, cut off the electricity supply to the appliance: remove the screw fuse from the holder or switch the circuit breaker off, or unplug from the mains socket.

How to avoid damaging the appliance

- Turn off the water tap during longer absences.
- Do not exceed the maximum loading weight for the lower basket, upper basket and cutlery drawer.
- Please note: The appliance must be connected to the mains supply to ensure appliance protection (overflow protection, among other things).
- Transport the appliance in an upright position only! Transporting it in any other position will result in damage to the appliance! When carried carefully without being shaken, the appliance may be tilted a maximum of 90° to the left (viewed from the front).

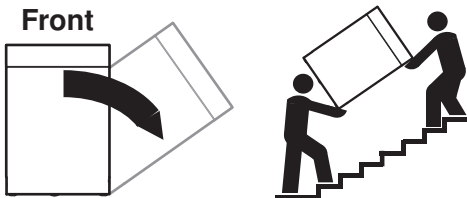

2 Using for the first time



The appliance must be installed and connected to the electricity supply by a qualified fitter/electrician in accordance with the separate installation instructions.

2.1 Before using for the first time

Before operating the newly installed appliance for the first time, the following steps should be taken:

- ▶ Switch on the power and turn on the water tap.
- ▶ Set the water hardness G in the user settings (see page 35).
- ▶ Fill the salt reservoir with approx. 1.0 l water and 1 kg regeneration salt (see page 39).
- ▶ Wipe away any excess salt around the edge of the salt reservoir.
- ▶ Fill the rinse agent reservoir with rinse agent (see page 40).
- ▶ Run the «Intensive»  programme without dishes to protect the appliance from corrosion from any excess salt and to remove traces of grease left behind from the manufacturing process.



The G refill indicator can flash during the first few wash cycles. G goes out when the salt concentration in the reservoir is evenly distributed.

2.2 Setting the door weight

Testing the 30° opening angle

- ▶ Check whether the appliance door stays open at an opening angle of approx. 30°.

If the appliance door swings open in an uncontrolled fashion:

- ▶ Open the appliance door approx. 30° and hold it in this position.
- ▶ Tighten the screws until the appliance door stays open in this position on its own.

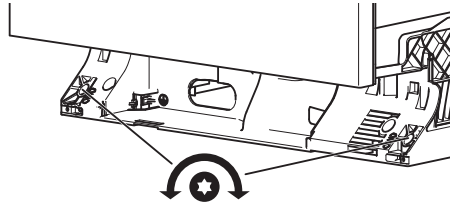

Testing the 90° opening angle

- ▶ Check whether the appliance door stays open at an opening angle of 90°.

If the appliance door comes up:

- ▶ Open the appliance door approx. 30° and hold it in this position.
- ▶ Loosen the screws until the appliance door stays open in this position on its own.

3 Appliance description

3.1 Construction

Interior

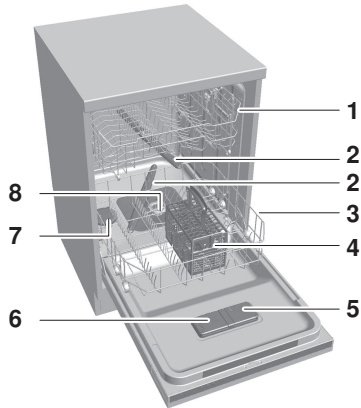

- 1 Upper basket
- 2 Spray arms
- 3 Lower basket
- 4 «Large» cutlery basket
- 5 Rinse agent reservoir
- 6 Detergent dispenser
- 7 Salt reservoir
- 8 Filter system

Appliance door

For integrated models, the operating and display elements are located on the **outside** of the appliance door.

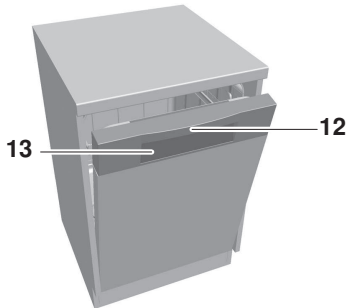

- 12 Door handle
- 13 Operating and display elements

For fully integrated models, the operating and display elements are located on the **inside** of the appliance door.

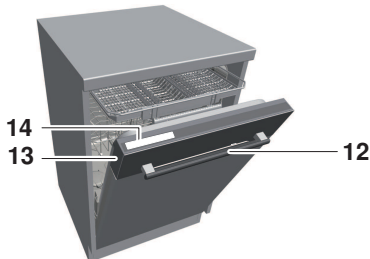

- 12 Door handle
- 13 FunctionLight *
- 14 Operating and display elements

* Depending on model

3.2 Operating and display elements

Main menu

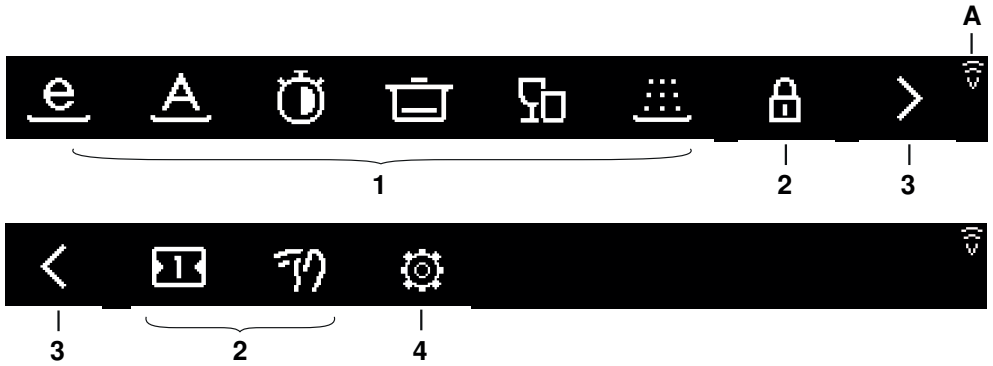

Buttons

- 1 Programmes (see page 13)
- 2 Frequently used user settings (see page 15)
- 3 Navigation elements
- 4 Other user settings (see page 35)

Display

A V-ZUG-Home

Programme selected

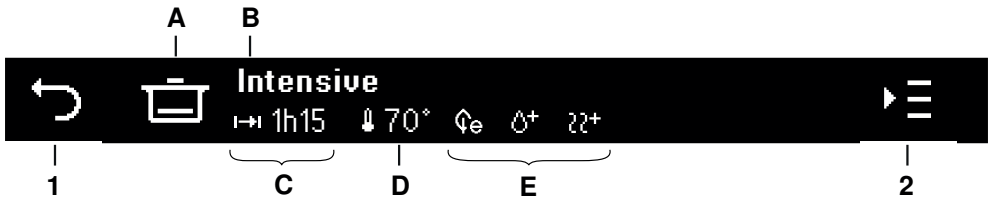

Buttons

- 1 Back arrow button
- 2 Setting options (see page 14)

Displays

- A Programme symbol
- B Programme name
- C Programme time
- D Temperature
- E Selected setting options

Button state



- A Non-selectable functions
- B Function selected
- C Selectable functions
- D Non-selectable navigation elements

Action elements

- + Increase value
- Decrease value
- Activate user setting
- Deactivate user setting
- ✕ Cancel entry, confirm message
- ▶ Start permanent mode programme, empty storage tank





Navigation elements

- ↶ Go back to the previous menu
- < Display other functions in the menu
- > Display other functions in the menu
- ∨ Display other selection options in the menu

3.3 FunctionLight *

* Depending on model

Colour of LED displays

- | | | |
|---|---|--|
|  Dark |  Orange |  White |
| |  Dimmed orange |  Dimmed white |

Programmes

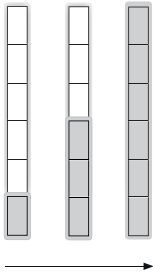

The progress display provides information about the progress of a programme. The more LEDs illuminate orange, the less remaining time is left. All 6 LEDs illuminate orange when a programme ends.

Final drying phase

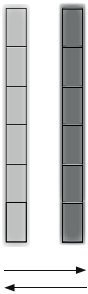

During the final drying phase, all 6 LEDs illuminate orange and pulsate between dimmed and undimmed.

Delayed start

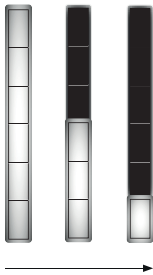

When the appliance door is closed and a delayed start is started, all 6 LEDs illuminate dimmed white.

Programme-independent appliance reactions

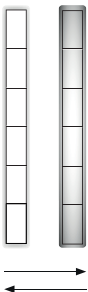

In the case of the following appliance reactions, all 6 LEDs illuminate white and pulsate between dimmed and undimmed:

- Aborting programmes, delayed start
- Pumping off

Error messages



In the event of A/F/U messages, the bottom 3 white LEDs and the top 3 white LEDs flash alternately.

4 Functions

Selection buttons enable the user to select and start frequently used programmes simply and quickly at the touch of a button. The user can create and change a selection button for any favourite programme and thus adapt it perfectly to their own work processes.

4.1 Programmes

Consumption values



The programme time (h), water consumption (l) and energy consumption (kWh) are indicative values. The values can also vary according to the selection of additional functions, the load, the degree of soiling of the load, the type and amount of detergent, the water inlet temperature, the electrical connection and specific programme sequences (e.g. regeneration).







The programme time, water consumption and energy consumption can be reduced by selecting the «Energy saving»  setting option.

Programme times

The stated values exclude the final drying time.

 Eco	Programme phases	Consumption values
The most efficient programme in terms of water and energy consumption for washing normally soiled dishes (declaration programme).	<ul style="list-style-type: none"> ▪ Cleaning: 45 °C ▪ Intermediate rinsing ▪ Rinsing with rinse agent: 55 °C ▪ Drying 	<ul style="list-style-type: none"> ▪ 5h55 ▪ 9.8 l ▪ 0.715–0.732 kWh
 Automatic	Programme phases	Consumption values
Optimum cleaning results with minimal water and energy consumption. For normal soiling. Not suitable for burned-on or heavily dried-on soiling.	<ul style="list-style-type: none"> ▪ Pre-rinsing (if required): cold ▪ Cleaning: 50–60 °C ▪ Intermediate rinsing (if required) ▪ Rinsing with rinse agent: 70 °C ▪ Drying 	<ul style="list-style-type: none"> ▪ 1h05–1h50 ▪ 8–20 l ▪ 0.9–1.5 kWh

 Quick	Programme phases	Consumption values
For lightly soiled dishes.	<ul style="list-style-type: none"> ▪ Cleaning: 45 °C ▪ Intermediate rinsing ▪ Rinsing with rinse agent: 60 °C ▪ Drying: Quick 	<ul style="list-style-type: none"> ▪ 0h39 ▪ 11 l ▪ 0.8 kWh
 Intensive	Programme phases	Consumption values
For heavy soiling. Particularly suitable for starchy soiling (e.g. mashed potato, rice).	<ul style="list-style-type: none"> ▪ Pre-rinsing (if required): 35 °C ▪ Cleaning: 65 °C ▪ Intermediate rinsing ▪ Rinsing with rinse agent: 70 °C ▪ Drying 	<ul style="list-style-type: none"> ▪ 1h50 ▪ 18–23 l ▪ 1.4–1.65 kWh
 Glass	Programme phases	Consumption values
Gentle programme for glasses.	<ul style="list-style-type: none"> ▪ Cleaning: 45 °C ▪ Intermediate rinsing ▪ Rinsing with rinse agent: 60 °C ▪ Drying 	<ul style="list-style-type: none"> ▪ 0h39 ▪ 11 l ▪ 0.8 kWh
 Pre-rinsing	Programme phases	Consumption values
Prevents soiling drying on if intending to start a programme later.	<ul style="list-style-type: none"> ▪ Pre-rinsing: cold 	<ul style="list-style-type: none"> ▪ 0h07 ▪ 4 l ▪ 0.05 kWh

4.2 Setting options

Energy saving

The wash temperature is reduced by 5 °C, lowering energy consumption by approx. 10 %. The programme time is shortened slightly. «Energy saving» is also gentle on glasses.

Delayed start

The delayed start allows you to wash during off-peak hours (e.g. at off-peak electricity rates). A delayed start of between 30 minutes and 24 hours can be set.

RinsePlus

The cleaning effect is improved through additional rinsing cycles and an extended cleaning phase. If RinsePlus is turned on, the amount of water used with each programme is increased. This extends the programme time.

DryPlus

The temperature of both the final rinse and the SteamFinish are increased and the drying time is extended.

4.3 Frequently used user settings

Childproof lock

The «Childproof lock» user setting prevents a programme from being started accidentally. If the childproof lock is turned on, it can be overridden by entering the four-digit code (1223). The code is set at the factory and cannot be changed.

All in 1

The «All in 1» user setting adapts the programme ideally for use with detergent with integrated salt and rinse agent function. Combination cleaning agents are not suitable for all degrees of water hardness (see page 22).

Wipe protection

The operating panel is locked briefly, e.g. for cleaning purposes.

5 Loading

5.1 Preparing the appliance

- ▶ Remove any coarse or hard pieces of food or foreign objects (such as toothpicks) left on the dishes.
- ▶ Load the baskets. After loading, check that the spray arms can turn freely.

5.2 Loading tips for the lower basket



Overloading the basket can damage the appliance!

Do not exceed the maximum loading weight for the lower basket of **21 kg**.

Loading larger items

- ▶ Load larger items such as plates, bowls, platters, pots and pans at the front.
- ▶ Load wide items such as soup plates and lids at the back on the right.

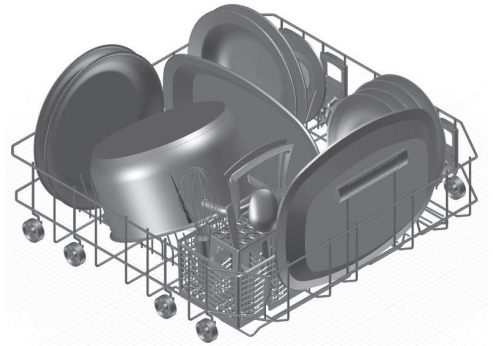

Stabilizing drinking vessels with easy prongs

- ▶ Put easy prongs **1** over basket prongs.
- ▶ Arrange drinking glasses, baby bottles, vases and carafes.
- ▶ Use two easy prongs for wider vessels.



Loading the cutlery basket

Risk of injury from being loaded incorrectly!

Place knives and cutlery with sharp edges or points into the cutlery basket with the points facing downwards. Make sure that they do not stick out of the cutlery basket.

Sharp objects can damage the appliance!

Do not insert knives, forks or other pointed objects in the opening of the door lock.

- ▶ Raise the basket prongs.
- ▶ Place the cutlery basket over the raised prongs anywhere in the basket.
- ▶ Distribute knives and the like among the compartments, with the points facing downwards.
- ▶ Distribute the rest of the cutlery loosely among the compartments, with handles pointing down.
- ▶ Spoons should not be stuck together.
- ▶ To prevent items of cutlery sticking together, water spots during drying, and smaller items slipping through the basket, put the inserts **1** supplied on the cutlery basket **2**.

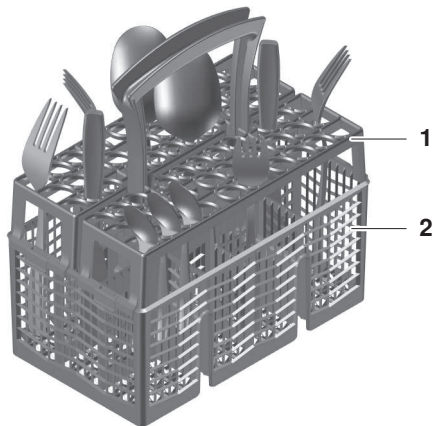

Risk of water leakage!

When closing the appliance door, ensure no items of cutlery are sticking out of the tub or are trapped. The leak tightness of the appliance cannot otherwise be assured.

- ▶ Check that cutlery is standing upright in the cutlery basket.

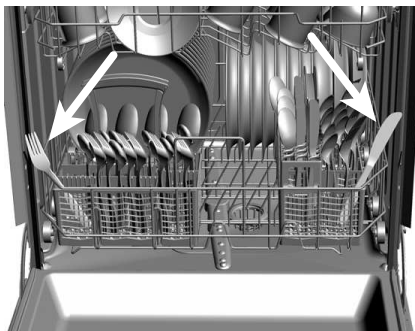

5.3 Loading tips for the upper basket



Overloading the basket can damage the appliance!

Do not exceed the maximum loading weight for the upper basket of **9 kg**.

Loading smaller items

- ▶ Arrange smaller items such as saucers, glasses, cups and dishes.
- ▶ If using the fold-down racks **1**, stagger the items.
- ▶ Rest glasses on the fold-down glass holders **2**.

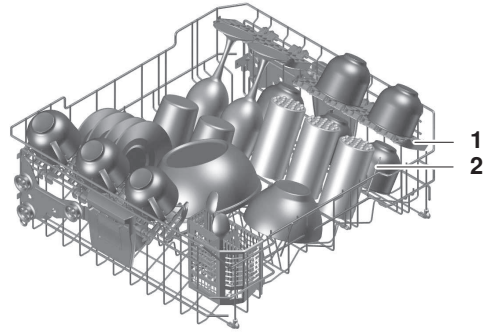

Stabilizing drinking vessels with easy prongs

- ▶ Put easy prongs **1** over basket prongs.
- ▶ Arrange drinking glasses, baby bottles, vases and carafes.
- ▶ Use two easy prongs for wider vessels.

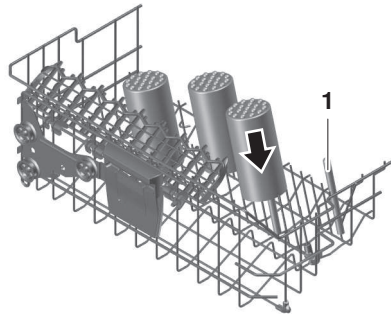

Loading tall glasses

For tall glasses, use glass holders and racks for greater stability. Remove the racks to accommodate tall glasses.

Glass holder

- ▶ Pull the glass holders **1** gently up until they engage.
- ▶ Rest tall glasses on the glass holder.

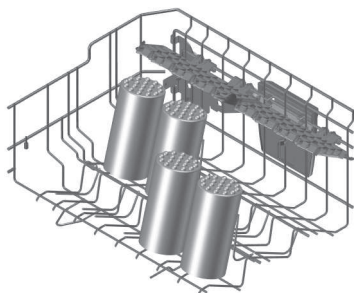
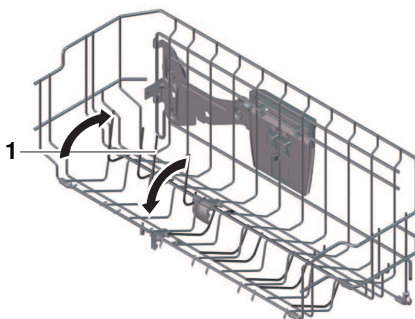

Rack

- ▶ Push the rack **1** up by the hooks **2**.
- ▶ Push the rack inward and then out.
- ▶ Hook the rack in the higher position **3**, if required.
- ▶ Rest stemmed glasses on the side of the basket.

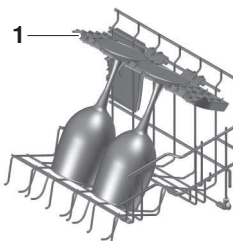
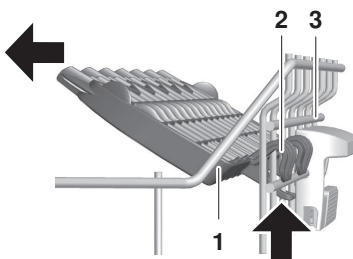

Adjusting the upper basket

Depending on the model, the height of the upper basket can be adjusted by around 2–4 cm. It can be inclined in various ways.

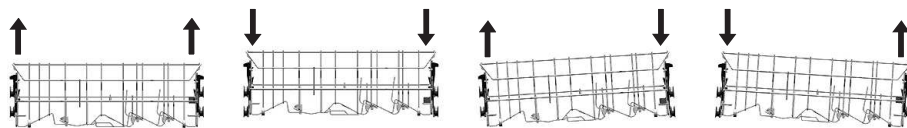

- ▶ Hold the upper basket at the sides by the grips **1** and raise it into the desired engaged position.
 - The upper basket is raised.

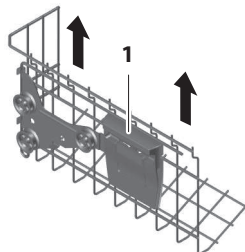

- ▶ Hold the upper basket at the sides by the grips **1**.
- ▶ Raise the upper basket slightly and press the button **2** at the same time.
 - The locking device is released.
- ▶ Lower the upper basket into the desired position, release the button and engage in position.
 - The upper basket is lowered.

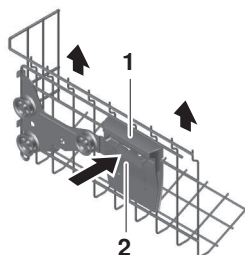

Removing the upper basket

- ▶ Pull the upper basket out almost as far as it will go.
- ▶ Holding the lower rail ends **1** from below, press the basket stoppers **2** upwards with your index fingers and thumbs.
- ▶ Remove the basket stoppers **2**.
- ▶ Slide the upper basket out.

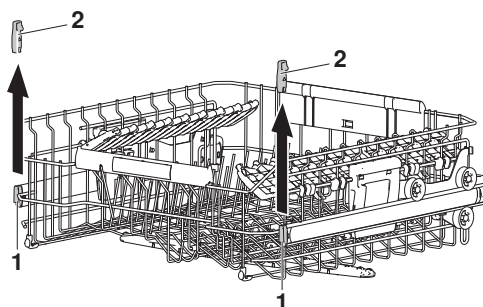

Inserting the upper basket

- ▶ Extend the rails **1** as far as they will go.
- ▶ Slide the upper basket on to the rails **1** in such a way that the rollers **2** of the upper basket come to rest on the rails.
- ▶ Push the basket stoppers **3** on to the rail ends **4** and press tight.

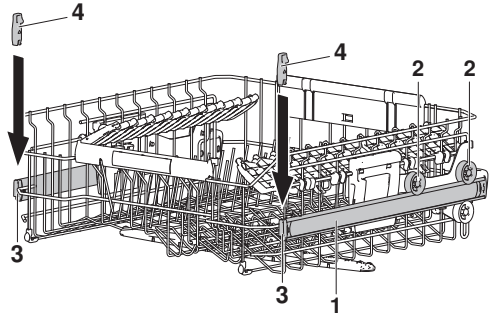

6 Operation

6.1 Dish washing tips

General note

- Do not overload the baskets.
- Dishes, pots and pans with heavily burned-on food debris stuck to them should be soaked in water first.
- Load beverage and food containers such as cups, glasses, pots, etc. with the opening facing downwards so that the water can drain off.
- When loading, ensure glasses do not touch so as to prevent damage and water spots.
- When cleaning range hood grease filters, select the «Intensive»  programme and use the maximum amount of detergent.

Dishes

Not all table- and kitchenware are dishwasher safe.

- Clean wooden or plastic parts that are sensitive to damage from heat and detergent suds by hand.
- Pottery has a tendency to crack or chip.
- The printing on glass and porcelain is hard-wearing only to a point and eventually over time can wear off.
- Glassware, depending on the type and the detergent being used, can become cloudy. Check with your glassware supplier as to whether your glassware is dishwasher safe.
- Stress and tension in thick cut crystal glasses and dishes can cause cracking.
- Do not wash dishes with adhesive labels on them. Adhesive labels can come off and clog up the filter system.
- Objects made of silver, copper and tin tend to discolour, turning brown or black.
- Spots tend to form on aluminium. Wash aluminium separately or by hand.

6.2 Selecting detergent

General note



Do not use washing-up liquid! Strong foaming can cause the appliance to malfunction. Follow the dosage instructions printed on the detergent packaging exactly.

Should you have any questions, please contact the detergent manufacturer. Using too high or too low a dosage can cause damage to the appliance.



- ▶ Only use detergent suitable for dishwashers (tabs, powder, gel, combination cleaning products).

Tabs

Tabs are suitable for programmes with wash temperatures of over 55 °C. Tabs may not dissolve properly at a wash temperature of below 55°C, affecting the cleaning performance of the appliance.

Combination cleaning products (tabs/powder)

If using combination cleaning products, which should render the use of rinse agent and regeneration salt superfluous, please observe the following tips:

- ▶ Check that the water hardness range indicated by the detergent manufacturer on the product packaging matches the hardness of your local water supply.
- ▶ Activate the «All in 1»  frequent user setting (see page 33).
 - The programmes and displays are adapted to suit the combination cleaning product.
- ▶ If the  refill indicator flashes, refill the salt reservoir with regeneration salt (see page 39).
- ▶ If the  refill indicator flashes, refill the rinse agent reservoir with rinse agent (see page 40).

If, after washing and drying, the results are not satisfactory:

- ▶ use conventional cleaning products.
- ▶ Deactivate the «All in 1»  frequent user setting (see page 33).

For complaints, contact the detergent manufacturer.

6.3 Adding the detergent



Ensure no cleaning agent gets into the opening of the door lock. This can cause the door lock to malfunction.

Powder

- ▶ Open the detergent dispenser **2** by pushing the release catch **1** in the direction of the arrow.

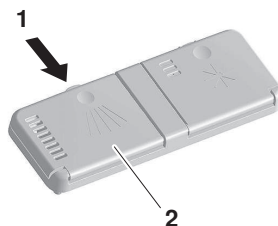

- ▶ Observe the «20 and 30 ml» level marks **3**.
- ▶ Add the detergent to the detergent dispenser. For dosage, follow the detergent manufacturer's instructions.
- ▶ For heavier soiling, add approx. 1 teaspoon of detergent to the pre-rinsing compartment **4**.
- ▶ Close the cover **5**.

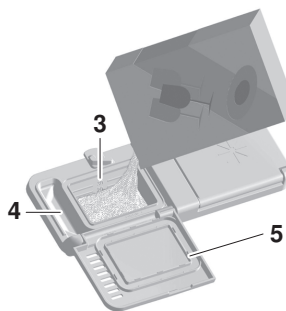

Tabs

- ▶ Place the tab **6** flat in the detergent compartment.
- ▶ Close the cover **5**.

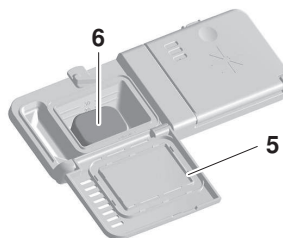

6.4 Operating the display

Programmes, setting options, user settings, permanent mode and favourites can be selected by touching or holding depressed the relevant buttons.

Touching a button

Briefly touching a selectable or selected button enables the user to

- change from one menu into the next highest level.
- display other functions in the same menu.
- activate selectable functions.
- deactivate selected functions.

Holding a button depressed

Holding a button depressed enables the user to easily

- save a programme as a ♥ favourite (see page 30).
- delete a 🗑 favourite (see page 31).
- get information ⓘ about a function (see page 33).
- use a programme in permanent ∞ mode (see page 29).

For programmes

- ▶ Hold the button for the desired programme, e.g. 🗄, depressed until the ♥, ⓘ and ∞ buttons appear in the display next to the programme selected.



For favourites

- ▶ Hold the button for the desired favourite, e.g. 🗄♥, depressed until the 🗑, ⓘ and ∞ buttons appear in the display next to the favourite selected.



For setting options and all user settings

- ▶ Hold the button for the desired function depressed until the ⓘ button appears in the display next to the desired function.

6.5 Selecting and starting a programme

Selecting a programme

- ▶ Touch the dark display.
 - The start screen appears.
- ▶ On the start screen, touch the > button repeatedly until the desired programme appears.
- ▶ Touch the desired programme, e.g. .
 - The programme selected appears in the display.



- ▶ Touch the  button to add setting options.
 - A selection of setting options appears in the display.



- ▶ Touch the desired setting option, e.g. .
- ▶ Use the programme in permanent mode (see page 29) or save it as a favourite (see page 30), as required.

Changing programme selection

- ▶ Touch the  button repeatedly until the start screen appears.
 - The selection made has been discarded.
- ▶ Make a new selection.

Cancelling programme selection

- ▶ Touch the  button repeatedly until the start screen appears.
- ▶ Close the appliance door.
 - The display goes dark.

Starting a programme

- ▶ Once all the necessary settings for the programme have been made, close the appliance door.
 - The programme starts immediately.
 - Depending on the model, the FunctionLight illuminates.



If the appliance door is not closed within 30 seconds, all entries, symbols and the display are cleared; an acoustic signal is also emitted. The programme must be selected again.

6.6 Adding extra dishes

 **The dishes and water may be hot. Scalding hazard!**

- ▶ Open the appliance door carefully.
 - This interrupts the programme.
 - The interrupted programme alternates in the display with the «Close the door» message.



- ▶ Load the dishes (see page 16).
- ▶ Close the appliance door.
 - The programme is resumed.

6.7 Aborting a programme before time

 **The dishes and water may be hot. Scalding hazard!**

- ▶ Open the appliance door carefully.
 - This interrupts the programme.
 - The interrupted programme alternates in the display with the «Close the door» message.



- ▶ Touch the X button.
 - The following message appears in the display:

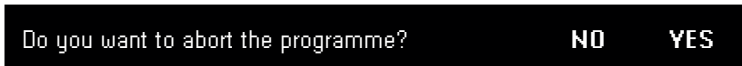

- ▶ Touch «YES».
 - In the display appears: «The programme is aborted...»
 - The water is pumped off.
 - A 5x acoustic signal is emitted.
 - The display goes out.
 - The programme is aborted.

6.8 Unloading dishes

The dishes can be unloaded either at the end of the programme or when the final drying phase finishes. For optimum drying results, it is recommended that the appliance only be unloaded after the final drying phase has finished.

End of programme and final drying phase

When the programme has finished,

- a 5× acoustic signal is emitted.

Then the final drying phase begins:

- Depending on the model, either the display illuminates or the FunctionLight flashes.
- The appliance door opens automatically.
- Depending on the model, the duration remaining of the final drying phase appears in the display.



Closing the appliance door can damage the appliance!

The appliance door must not be closed after opening automatically. The door opener could otherwise get damaged!

When the final drying phase has finished,

- 3 long acoustic signals are emitted.
- the energy and water consumption of the programme appears in the display for about 10 seconds.
- the display goes out.
- the appliance enters the energy-saving «EcoStandby» mode.

Unloading the appliance

- ▶ Remove the dishes. Unload the lower basket first.
- ▶ Periodically check the filter system and clean if necessary (see page 39).



7 Programme options

7.1 Delayed start



The delayed start allows you to wash during off-peak hours (e.g. at off-peak electricity rates). It can be set briefly after selecting a programme.

A delayed start of between 30 minutes and 24 hours can be set.

Setting the delayed start duration

- ▶ On the start screen, touch the  button repeatedly until the desired programme appears.
- ▶ Select the desired programme and any desired setting options (see page 25).
- ▶ Touch the  button.
- ▶ Touch the  button.
 - The delayed start menu appears in the display.





- ▶ Touch the  or  button repeatedly until the desired duration appears.
- ▶ Touch the  button.
 - The setting options menu appears in the display.
 - The duration selected is saved.
- ▶ Close the appliance door.
 - Depending on the model, the display goes dark.
 - The set duration counts down.
 - When the delayed start duration is up, the programme selected starts automatically.
 - No acoustic signal is emitted at the end of the programme.



Dishes can be loaded at any time during the delayed start.





Cancelling a delayed start and programme

- ▶ Open the appliance door.
- ▶ Touch the  button.
- ▶ Touch the  button.
- ▶ Touch the  button repeatedly until «0h00» appears.
 - The delayed start and programme are cancelled.

7.2 Programme in permanent mode

Only one programme can be used in permanent mode. When the appliance door is opened, the programme appears on the start screen and can be started immediately. A programme used in permanent mode can be deleted at any time.

Saving a programme as permanent mode

- ▶ On the start screen, touch the > button repeatedly until the desired programme appears.
- ▶ Hold the button for the desired programme, e.g. , depressed until the ,  and  buttons appear in the display next to the programme selected.



- ▶ Touch the  button and confirm the prompt with «YES».
 - The programme used in permanent mode appears in the display.



Starting a permanent mode programme

- ▶ Open the appliance door.
 - The programme used as permanent mode appears in the display.
- ▶ Touch the  button.
- ▶ Close the appliance door.
 - The programme starts.

Ending permanent mode





- ▶ Open the appliance door.
 - The programme used as permanent mode appears in the display.
- ▶ Touch the  button and confirm the prompt with «YES».
 - The start screen appears in the display.
 - The permanent mode is ended.

7.3 Favourites



Up to 5 programmes with or without setting options can be saved as favourites. Programmes saved as favourites appear on the start screen after the «Eco»  programme and can be deleted at any time.

Creating favourites without setting options

 This function is suitable for displaying programmes on the start screen that are not displayed on it by default.

- ▶ On the start screen, touch the  button repeatedly until the desired programme appears.
- ▶ Hold the button for the desired programme, e.g. , depressed until the ,  and  buttons appear in the display next to the programme selected.





- ▶ Touch the  button and confirm the prompt with «YES».
 - The programme selected appears in the display with a heart, e.g. .



Creating favourites with setting options



- ▶ Select a programme along with setting options (see page 25).







- ▶ Touch the  button and confirm the prompt with «YES».
 - The programme selected appears in the display with a heart, e.g. .



Starting favourites

- ▶ On the start screen, touch the  button repeatedly until the desired favourite appears.
- ▶ Touch the button for the desired favourite, e.g. .
- ▶ Adjust the setting options as required (see page 25).
- ▶ Once all the necessary settings for the programme have been made, close the appliance door.
 - The programme starts immediately.
 - Depending on the model, the FunctionLight illuminates.

Using favourites in permanent mode





- ▶ On the start screen, touch the > button repeatedly until the desired favourite appears.
- ▶ Hold the button for the desired favourite, e.g. , depressed until the ,  and  buttons appear in the display next to the favourite selected.



- ▶ Touch the  button and confirm the prompt with «YES».
 - The programme used in permanent mode appears in the display.



Deleting favourites



- ▶ On the start screen, touch the > button repeatedly until the desired favourite appears.
- ▶ Hold the button for the desired favourite, e.g. , depressed until the ,  and  buttons appear in the display next to the favourite selected.





- ▶ Touch the  button and confirm the prompt with «YES».
 - The favourite is deleted.

7.4 Permanently selecting setting options

Assigning setting option to each programme

- ▶ On the start screen, touch the > button repeatedly until «User settings»  appears.
- ▶ Select the «Setting options Permanent selection»  user setting.
 - The «Setting options Permanent selection»  user setting appears.



- ▶ Touch the desired setting option, e.g. .
 - The setting option selected appears in the display with a drawing pin, e.g. .



- The next time a programme is selected, the setting option selected is automatically assigned to each programme.
- ▶ Permanently select other setting options as required.
- ▶ Touch the  button to access the main user settings menu.



Temporarily turning off a permanent setting option



- ▶ Touch the desired programme, e.g. .
 - The programme selected appears in the display.



- ▶ Touch the  button.
 - A selection of setting options appears in the display.







- ▶ Touch the permanently selected setting option, e.g. .
 - The «Energy saving»  setting option is temporarily turned off for the «Intensive»  programme.
- ▶ Select other setting options as required.
- ▶ Start the programme (see page 25).

 When the «Intensive»  programme is selected in the future, all permanently selected setting options appear again.

7.5 Childproof lock

Activating

- ▶ On the start screen, touch the  button repeatedly until the frequently used user setting «Childproof lock»  appears.
- ▶ Touch the  button.
- ▶ Touch the  button.
 - In the display appears: «To activate or unlock the childproof lock, please enter the code 3221 backwards.»
- ▶ Touch the  button to confirm the message.
 - The input field for the code appears in the display.

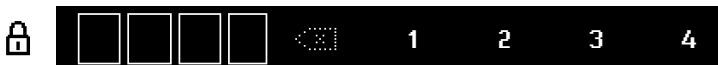



- ▶ Enter the code as explained in the «Frequently used user settings» section (see page 15).
 - The childproof lock is activated.

Operation with the childproof lock activated

The childproof lock has to be overridden before a programme can be selected. EcoManagement data, however, can be retrieved without overriding the childproof lock.



- ▶ Open the appliance door.
 - The input field for the code appears in the display.
- ▶ Enter the code as explained in the «Frequently used user settings» section (see page 15).
 - The appliance is unlocked.
 - The appliance can be operated as usual.

Deactivating



- ▶ On the start screen, touch the > button repeatedly until the frequently used user setting «Childproof lock»  appears.
- ▶ Touch the  button.
- ▶ Touch the  button.
 - The childproof lock is deactivated.

7.6 All in 1



Activating

- ▶ On the start screen, touch the > button repeatedly until the frequently used user setting «All in 1»  appears.
- ▶ Touch the  button.
 - «All in 1» is activated.
- ▶ Touch the  button to access the start screen.
- ▶ Add the combination cleaning agent (see page 23).
- ▶ Select a programme (see page 25).



Deactivating

- ▶ On the start screen, touch the > button repeatedly until the frequently used user setting «All in 1»  appears.
- ▶ Touch the  button.
 - «All in 1» is deactivated.
- ▶ Touch the  button to access the start screen.

7.7 Wipe protection

- ▶ On the start screen, touch the > button repeatedly until the user setting «Wipe protection»  appears.
- ▶ Touch the  button.
 - The display is locked for 10 seconds.
 - The countdown to the unlocking of the display is shown.
 - The start screen appears as soon as the display is unlocked.

7.8 Information

- ▶ Hold the button for the desired function depressed until the  button appears in the display next to the desired function.
- ▶ Touch the  button.
 - A description of the function appears in the display.



Energy saving: Wash temperature is reduced by 5 °C.
Energy consumption is reduced by 10 % .

- ▶ Touch the  button to close the information.

8 V-ZUG-Home

8.1 Conditions

The following conditions must be met for full use of V-ZUG-Home:

- Access to the internet and to Google Play™ Store / App Store®
- a wireless network that meets one of the following standards: 2.4GHz 802.11 b/g/n
- Smartphone or tablet that is connected to the wireless network
- System requirements for smartphone or tablet: from Android 6.0 or from iOS 11.0



Google Play™ is a trademark of Google Inc.



Apple and the Apple logo are trademarks of Apple Inc., registered in the U.S. and other countries. App Store® is a service mark of Apple Inc.

8.2 Initial set-up



When establishing a connection, stay close to your appliance and have the password for your wireless network at the ready.

Installing the app

- ▶ Enable bluetooth and location determination on the smartphone or tablet.
- ▶ Search the Google Play™ Store or the App Store® for «V-ZUG».
- ▶ Install and open the V-ZUG App.

Enabling the V-ZUG-Home mode on the appliance

- ▶ Set to the «Display» or «Operate» mode under «V-ZUG-Home» in the user settings.

Connecting the appliance to the home network

- ▶ In the V-ZUG App, add the appliance.
 - A bluetooth pairing request appears in the V-ZUG App.
 - A 6-digit PIN appears in the display of the appliance.
- ▶ Enter the 6-digit PIN in the V-ZUG App and confirm the bluetooth pairing request.
 - All available wireless networks appear in the V-ZUG App.
- ▶ Select your wireless network.
- ▶ Enter the password for your wireless network.
 - The appliance is connected to your wireless network.



Further information about V-ZUG-Home and availability can be found at home.vzug.com or in the Operating instructions for V-ZUG-Home.

9 User settings

9.1 Changing the user settings

The user settings can be changed at any time.

- ▶ On the start screen, touch the > button repeatedly until ⚙ «User settings» appears.
- ▶ Touch the ⚙ button.
 - The user settings menu appears in the display.



- ▶ Touch the > button repeatedly until the desired user setting appears.
- ▶ Touch the desired user setting.
 - The user setting selected appears white.
- ▶ Make the desired setting.
- ▶ Touch the ↶ button to access the main user settings menu.

9.2 Overview of user settings



Language

Selection

The language in the display can be changed. Different languages are available for selection.

- English
- (...)



Brightness

Selection

The brightness of the display can be changed using the + and – buttons. Five different levels of brightness are available for selection.

- Level 1: very dark
- Level 2: dark
- Level 3: medium (factory setting)
- Level 4: bright
- Level 5: very bright



Signals and tones

Selection

There are 2 types of signal or tone: button tones and acoustic signals . Button tones are emitted when buttons are touched. Acoustic signals are emitted when a programme ends, when the final drying phase finishes and in the event of a malfunction. The loudness of both signals and tones can be changed or turned off. Two different levels of loudness are available for selection.

- : Off
- : Low (factory setting)
- : High



Setting options Permanent selection

Selection

Touch a setting option to assign it automatically to each programme (see page 31). The «Energy saving» setting option is not activated for the «Pre-rinsing» programme.

- : Energy saving
- : Delayed start
- : RinsePlus
- : DryPlus



Rinse agent dosage

Selection

The rinse agent dosage is automatically adjusted to the load and the water hardness. If the drying result is unsatisfactory, the dosage can be set manually to one of 12 levels. The rinse agent dosage can be turned off .

- Automatic (factory setting)
- Level 1–12
- Off



Water hardness

Selection

The unit of water hardness can be set to «°fH» or «°dH». The water hardness setting can be changed to suit local conditions. Contact your local water authority or see www.trinkwasser.ch for the relevant information.

- °fH: French degree of hardness (factory setting: 26–30)
- °dH: German degree of hardness

	Soft		Medium			Hard			Very hard				
°fH	0–	6–	11–	16–	21–	26–	31–	36–	41–	51–	61–	71–	81–
	5	10	15	20	25	30	35	40	50	60	70	80	120
°dH	0–	4–	7–	10–	13–	15–	17–	20–	23–	28–	33–	39–	45–
	3	6	9	12	14	16	19	22	27	32	38	45	65



Temperature unit

Selection

The temperature unit can be displayed in «°C» or «°F».

- °C: Degrees Celsius (factory setting)
- °F: Degrees Fahrenheit



FunctionLight *

Selection

The brightness of the illumination of the door gap can be changed or deactivated using the + and – buttons. Three different levels of brightness are available for selection.

- : Activated (factory setting: Level 2)
- : Deactivated

* Depending on model













Automatic door opener

Selection

If the user setting is activated, the appliance door opens slightly automatically during the drying and final drying phase to save energy. If the user setting is deactivated, the programme time is extended by 10 minutes.

- : Activated (factory setting)
- : Deactivated

 Automatic stand-by	Selection <ul style="list-style-type: none"> ▪ <input checked="" type="checkbox"/>: Activated (factory setting) ▪ <input type="checkbox"/>: Deactivated
<p>If the user setting is activated, the information in the display goes out at the end of the programme. If the user setting is deactivated, the information can be displayed by operating the appliance door. Press any button and the display then goes out.</p>	
 V-ZUG-Home	Selection <ul style="list-style-type: none"> ▪ <input checked="" type="checkbox"/>: Activated ▪ <input type="checkbox"/>: Deactivated (factory setting)
<p>With V-ZUG-Home, you can access your appliances over the V-ZUG App to, for instance, retrieve and change the user settings or retrieve various statistics about your household appliances.</p>	
 <p>Further information about V-ZUG-Home and availability can be found at home.vzug.com or in the Operating instructions for V-ZUG-Home.</p>	
 Hot water connection	Selection <ul style="list-style-type: none"> ▪ <input checked="" type="checkbox"/>: Activated ▪ : No heating ▪ <input type="checkbox"/>: Deactivated (factory setting)
<p>If the appliance has a hot water connection and the setting is activated, optimum use is made of the hot water available.</p> <p>For the «No heating»  setting: only enable if the inlet water is at least 60 °C. The dishes may not be completely dry by the end of the programme. Leave the dishes in the appliance (e.g. overnight) to dry.</p>	
 Deleting favourites	Selection <ul style="list-style-type: none"> ▪ : Deleting
<p>Touch «Delete»  and confirm the prompt to delete all the favourites.</p>	
 Factory setting	Selection <ul style="list-style-type: none"> ▪ YES ▪ NO
<p>With «YES», all user settings are reset to the factory settings.</p>	
Service settings	<p>The service settings (including the demo mode) are only available for use by V-ZUG Service staff.</p>

10 Care and maintenance

10.1 Cleaning the interior and exterior

Cleaning the interior

Using the correct dosage of detergent will automatically clean the interior of the appliance. The appliance should be additionally cleaned twice a year with dishwasher cleaner.

- ▶ Follow the instructions for use for the dishwasher cleaner.
- ▶ Select the «Intensive»  programme as dishwasher cleaners work more effectively at higher temperatures.

Cleaning the exterior

- ▶ Do not use abrasive or caustic cleaning agents.
- ▶ Do not use scouring pads, steel wool, etc. as they can damage the surface.
- ▶ Remove any soiling or excess cleaning solution immediately. Only use washing-up liquid or glass cleaner.
- ▶ Clean the surfaces with a soft, damp cloth only – for metal surfaces rub in the direction of the polish lines.
- ▶ Clean the operating panel with a damp cloth and then wipe dry. Only use washing-up liquid or glass cleaner.
- ▶ Regularly clean the door seal and edges with a soft, damp cloth.

10.2 Cleaning the spray arms

Upper spray arm

- ▶ Remove the upper basket.
- ▶ Release the bayonet fastener **1** in an anti-clockwise direction and remove.
- ▶ Remove the spray arm **2** from the shaft and rinse well under running water.
- ▶ Check the nozzles.

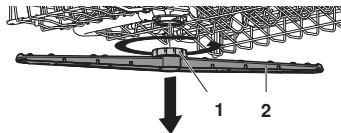

Lower spray arm

- ▶ Hold the spray arm **3** in the middle and pull hard upwards.
- ▶ Rinse the spray arm well under running water.
- ▶ Check the nozzles **4**.
- ▶ Clean the filter system **5** and the coarse filter (see page 39).

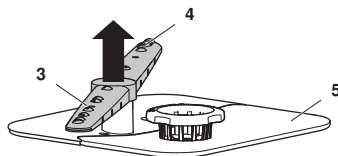

10.3 Cleaning the filter system

 Only use soft materials for cleaning beneath the filter system. Never use metal objects.

An incorrectly assembled filter system can cause the appliance to malfunction.

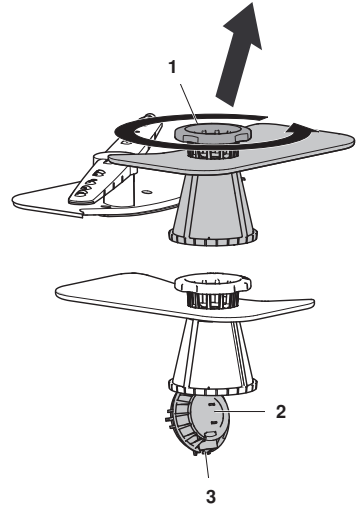

- ▶ Open the appliance door and pull out the lower basket.
- ▶ Release the filter system in fine filter **1** in an anti-clockwise direction and remove.
- ▶ Open the coarse filter **2** by pressing on closing lug **3** and clean the filter system under running water using a brush.
- ▶ Remove any coarse debris.
- ▶ Replace the filter system and turn the fine filter **1** as far as it will go in a clockwise direction.



10.4 Refilling with regeneration salt

 Never fill the salt reservoir with detergent!

When the supply of regeneration salt is exhausted, the  refill indicator flashes and the following appears in the display:

  Refill regeneration salt.
Then run the Pre-rinsing  programme.

- ▶ Open the box of regeneration salt.
- ▶ Open the appliance door and remove the lower basket.
- ▶ Open the cover **3** on the salt reservoir by lifting up the grip.

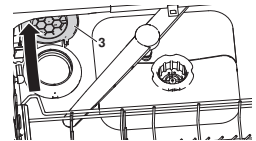

- ▶ **For initial set-up only:** First add 1 l water.
- ▶ Fill with 1 kg standard regeneration salt.
- ▶ Wipe away any excess salt around the edge of the salt reservoir.
- ▶ Close the cover **3** on the salt reservoir and engage the latch.
- ▶ Run the «Pre-rinsing»  programme without dishes to protect the appliance from corrosion from any excess salt.

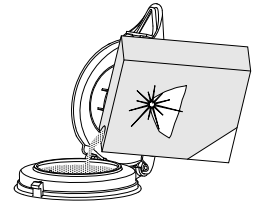

Approximate consumption of regeneration salt

The consumption of regeneration salt depends on the hardness of the water supply. The lower the water hardness, the greater the number of wash cycles per kg of regeneration salt.

Wash cycles per kg salt	∞	680	360	250	150	125	100	85	60	45	35	28	20
French degree of water hardness (°fH)	0–5	6–10	11–15	16–20	21–25	26–30	31–35	36–40	41–50	51–60	61–70	71–80	81–120
German degree of water hardness (°dH)	0–3	4–6	7–9	10–12	13–14	15–16	17–19	20–22	23–27	28–32	33–38	39–45	45–65

10.5 Filling with rinse agent

 **Never put detergent in the rinse agent reservoir! Wipe away any spilt rinse agent. Risk of foaming. Follow the manufacturer's safety instructions and warnings.**

Rinse agent prevents water spotting after final rinsing (rinsing with rinse agent).

When the supply of rinse agent is exhausted, the  refill indicator flashes and the following appears in the display:

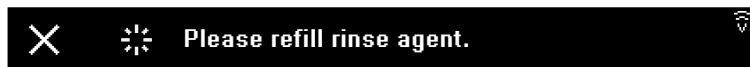

- ▶ Open the rinse agent reservoir **2** by pushing the release catch **1** in the direction of the arrow.
- ▶ Fill with rinse agent up to the «max» mark **3** (1.3 dl = approx. 35 wash cycles).
- ▶ Close the cover **4**.
- ▶ Wipe away any spilt rinse agent.

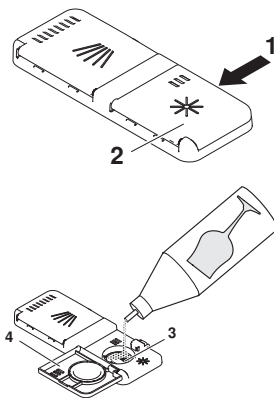

11 Trouble-shooting

You may be able to trouble-shoot the following errors yourself. If not, note down the error message in full and the serial number (SN), which can be found on the identification plate, and call Customer Services.

11.1 Error messages





In the event of error messages follow the instructions on the operating panel. After trouble-shooting a problem, touch X. The appliance can be operated as usual again.

- In the event of a malfunction, an acoustic signal is emitted for 1 minute.









Display	Possible cause	Solution
A0 Foaming?	<ul style="list-style-type: none"> ▪ High-foaming detergent was used. ▪ Spilt rinse agent. ▪ Washing-up liquid was used. 	<ul style="list-style-type: none"> ▶ Wipe away spilt rinse agent with a cloth. ▶ Get rid of the foam with approx. 1 dl edible oil. ▶ Cancel the error message by pressing the ✓ button. ▶ Run the «Pre-rinsing»  programme.
A1 Check filter system	<ul style="list-style-type: none"> ▪ Filter system is not inserted. ▪ Filter system is not fully locked in place. 	<ul style="list-style-type: none"> ▶ Clean filter system and re-insert correctly. ▶ Turn the fine filter as far as it will go in a clockwise direction (see page 39).
A2 Check water outlet	<ul style="list-style-type: none"> ▪ Filter system is clogged up. ▪ Drain hose is bent or kinked. ▪ Drain pump or drain trap is blocked. ▪ Excessive foaming due to rinse agent spillage. 	<ul style="list-style-type: none"> ▶ Clean the filter system (see page 39). ▶ Fix the problem. ▶ Cancel the error message by pressing the ✓ button. ▶ Restart the programme.
A9 Check water inlet	<ul style="list-style-type: none"> ▪ Water tap is turned off. ▪ Water inlet filter is blocked. ▪ Interruption in the water supply. ▪ Water pressure is too low. 	<ul style="list-style-type: none"> ▶ Fix problem or wait until water supply is restored. ▶ Cancel the error message by pressing the ✓ button. ▶ Restart the programme.
F8 / E18 see instructions / SN XXXXX XXXXXX	<ul style="list-style-type: none"> ▪ Water intake is hotter than 79 °C (hot water connection). 	<ul style="list-style-type: none"> ▶ Have a plumber reduce the temperature of the water intake.

Display	Possible cause	Solution
F... /E... see instructions / SN XXXXX XXXXXX	<ul style="list-style-type: none"> ▪ Various situations can lead to an «F» message. 	<ul style="list-style-type: none"> ▶ Cancel the error message by pressing the √ button. <p>If the error message persists:</p> <ul style="list-style-type: none"> ▶ Switch the power supply off for about 1 minute. ▶ Switch the power supply back on again. ▶ Cancel the error message by pressing the √ button. ▶ Restart the programme. ▶ If the error appears again, note down the error message and SN. ▶ Turn off the water tap and the power supply. ▶ Call Customer Services.
U... /E... see instructions	<ul style="list-style-type: none"> ▪ Faulty electrical connection. ▪ Overvoltage. 	<ul style="list-style-type: none"> ▶ Cancel the error message by pressing the √ button. <p>If the error message persists:</p> <ul style="list-style-type: none"> ▶ Switch the power supply off for about 1 minute. ▶ Switch the power supply back on again. ▶ Cancel the error message by pressing the √ button. ▶ Restart the programme. ▶ If the error appears again, note down the error message and SN. ▶ Switch the power supply off. ▶ Have the electrical installation checked by an expert.

11.2 Other possible problems

Problem	Possible cause	Solution
The appliance will not start.	<ul style="list-style-type: none"> ▪ There could be several reasons for this. <hr/> <ul style="list-style-type: none"> ▪ The «Demo mode» is activated. 	<ul style="list-style-type: none"> ▶ Close the appliance door. ▶ Insert plug into mains socket. ▶ Check the fuse or circuit breaker. ▶ See the «Operation with the child-proof lock activated» section (see page 32). ▶ If the appliance will still not start: call Customer Services. <hr/> <ul style="list-style-type: none"> ▶ Open the appliance door. ▶ On the start screen, touch the > button repeatedly until «User settings»  appears. ▶ Touch the  button. ▶ Touch the > button repeatedly until «Service settings»  appears. ▶ Touch the  button. ▶ Touch the  button and confirm the prompt. <ul style="list-style-type: none"> – The demo mode is deactivated.
An unpleasant smell tends to come from the appliance.	<ul style="list-style-type: none"> ▪ There could be several reasons for this. 	<ul style="list-style-type: none"> ▶ Clean the filter system (see page 39). ▶ Select a more powerful programme. ▶ Refill the salt reservoir with enough regeneration salt (see page 39).
The time display freezes for up to 4 minutes at the beginning of the programme or during the wash cycle.	<ul style="list-style-type: none"> ▪ Water softener is being flushed through after the regeneration process. ▪ The duration of the programme and the time display are being adjusted to the degree of soiling of the load. 	<ul style="list-style-type: none"> ▶ No action required.
The EcoManagement consumption values displayed are too high.	<ul style="list-style-type: none"> ▪ The values can vary according to programme, load, additional functions and user settings. ▪ The accuracy of the values determined by the appliance is subject to typical technical dispersion. 	<ul style="list-style-type: none"> ▶ Check the user settings selected and adjust as necessary (see page 35). ▶ Check the setting options selected and adjust as necessary (see page 14).

11.3 Unsatisfactory washing results

Problem	Solution
The dishes are not clean.	<ul style="list-style-type: none"> ▶ Select a more powerful programme. ▶ Load the baskets differently (see page 16), avoiding blind spots. ▶ Clean the filter system and re-insert correctly (see page 39). ▶ Check to see whether the spray arms are clogged or dirty (see page 38). ▶ Use the correct amount of detergent or use a different kind of detergent (see page 22). ▶ Set to the right water hardness  in the user settings (see page 35). ▶ Refill the salt reservoir with regeneration salt (see page 39).
There is a white film on the dishes.	<ul style="list-style-type: none"> ▶ Clean the appliance with dishwasher cleaner. ▶ Refill the salt reservoir with regeneration salt (see page 39) and run the «Pre-rinsing»  programme without dishes. ▶ Use the correct amount of detergent or use a different kind of detergent (see page 22). ▶ Refill the rinse agent reservoir with rinse agent (see page 40). ▶ Increase the rinse agent dosage  in the user settings (see page 35). ▶ Set to the right water hardness  in the user settings (see page 35). ▶ If not using detergent, touch the «All in 1»  frequently used user setting (see page 33).
There are streaks or milky spots on the dishes.	<ul style="list-style-type: none"> ▶ Reduce the rinse agent dosage  in the user settings (see page 35).
The dishes are wet and dull or have water marks on them.	<ul style="list-style-type: none"> ▶ Refill the rinse agent reservoir with rinse agent (see page 40). ▶ Increase the rinse agent dosage  in the user settings (see page 35). ▶ Use a different rinse agent. ▶ Do not open the appliance door until the end of the programme when a 3× acoustic signal is emitted and the display or the FunctionLight goes out (depending on model).
There are rust spots on the items being washed.	<p>The rust stems from another source e.g. the cutlery, pans, water pipe. The appliance is made of rust-free steel.</p> <ul style="list-style-type: none"> ▶ Refill the salt reservoir with regeneration salt (see page 39) and run the «Pre-rinsing»  programme without dishes.
The detergent is not fully dissolved.	<ul style="list-style-type: none"> ▶ Check whether the spray arms are clogged or dirty (see page 38). ▶ Use a different kind of detergent. ▶ Check the detergent dispenser cover. ▶ Check whether the filter system is clogged and clean if necessary. (see page 39)

Problem	Solution
There is discolouring of the baskets and plastic parts inside the appliance.	Dishes that still had discolouring food leftovers (e.g. tomato or curry sauce) on them or silver cutlery were washed. The discolouration may fade after a few wash cycles.

11.4 In the event of a power failure

- Any programme that is running will be interrupted. After the cause of the power supply failure has been resolved, the programme is resumed.
- The fault indication system is interrupted.

12 Accessories and spare parts

Please give model designation, model number and type of appliance when ordering parts.

12.1 Accessories



«Small» cutlery basket

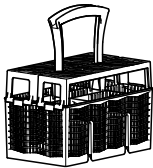

«Large» cutlery basket



Racks



Set of 4 easy prongs



Vario cutlery basket insert



Lower basket for glasses

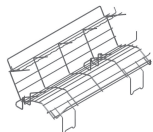

Cup support

12.2 Spare parts

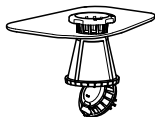

Filter system

13 Technical data

Dimensions	SMS 55	SMS 55 Extra height	EURO 60	EURO 60 Extra height
Appliance height (incl. slide plate 3 mm)	756 mm	827 mm	756 mm	827 mm
Appliance height (incl. adjustable plinth)	–	845–893 mm	780–828 mm	845–893 mm
Appliance width	546 mm	546 mm	596 mm	596 mm
Appliance depth	572 mm	572 mm	572 mm	572 mm
Appliance weight	42–48 kg	42–48 kg	42–48 kg	42–48 kg

Plumbing in

Cold or hot water up to 60 °C:	G $\frac{3}{4}$ "
Permitted pressure of water supply:	0.1–1.0 MPa (1–10 bar)
Max. pumping height:	1.2 m

Electrical connection

The electrical connection data can be found on the identification plate:

- ▶ Open the appliance door.
 - The identification plate is located on the left-hand side on the edge of the tub.

Ambient conditions

Minimum ambient temperature	+10 °C
-----------------------------	--------

13.1 Safety concept

Provided power is going to the appliance, the electronic control unit monitors the appliance. Any malfunctions are indicated by error messages.

13.2 Overflow protection



The overflow protection system does not function during a power failure. Turn off the water tap during longer periods of inactivity.

The electronic control unit monitors the water level in the appliance. In the event of a malfunction, the drain pump turns on, stopping the supply of water to the appliance.

13.3 Product fiche

In accordance with EU Regulation No. 1059/2010

Brand	-	V-ZUG Ltd	
Model identifier (the first 5 alphanumeric of the serial number (SN))	-	41091	41106
		41093	41107
		41094	41108
			41109
Rated capacity in standard place settings for the standard cleaning cycle	-	12	13
Energy efficiency class	-	A+++	
Annual energy consumption ¹⁾	kWh per year	201	206
Energy consumption of the standard cleaning cycle	kWh	0.715	0.732
Power consumption of the off mode	W	0.1	
Power consumption of the left-on mode	W	0.0	
Power consumption with network connected	W	0.9	
Weighted annual water consumption ²⁾	litres per year	2744	
Drying efficiency class on a scale from G (low efficiency) to A (most efficient).	-	A	
Standard programme ³⁾	-	Eco	
Programme duration for standard cleaning cycle	mins.	355	
Duration of the left-on mode	mins.	0	
Airborne acoustical noise emissions	dB (A)	43	43

1) Annual energy consumption based on 280 standard cleaning cycles using cold water fill and the consumption of the low-power modes. Actual energy consumption will depend on how the appliance is used.

2) Weighted annual water consumption based on 280 standard cleaning cycles. Actual water consumption will depend on how the appliance is used.

3) The standard programme to which the information in the fiche relates. This programme is suitable to clean normally soiled tableware and is the most efficient programme in terms of combined energy and water consumption.

13.4 Note for testing institutes

The note for testing institutes can be obtained from the internet: www.vzug.com/testinstitute.

13.5 Noise measurement

See the 'Note for testing institutes' section.

14 Disposal

14.1 Packaging



Never allow children to play with packaging material due to the danger of injury or suffocation. Store the packaging material in a safe location or dispose of it in an environmentally-friendly way.

14.2 Safety

Render the appliance unusable to prevent accidents caused by improper use (e.g. through children playing):

- ▶ Disconnect the appliance from the mains. With a fixed appliance, this is to be carried out by a qualified electrician. Then cut the mains cable off flush with the appliance.
- ▶ Remove or disable the lock on the appliance door.

14.3 Disposal



-  The «crossed out wheeled bin» symbol requires the separate collection of waste electrical and electronic equipment (WEEE). Such equipment can contain hazardous, environmentally harmful materials.
- These appliances are to be handed over to a designated collection point for the recycling of electrical and electronic equipment and must not be disposed of with unsorted household waste. And in this way, you will be helping to protect resources and the environment.
- For more information, please contact the local authorities.

Index

A	
A messages.....	41
Aborting	
Programme.....	26
Acoustic signal.....	35
All in 1.....	15, 22
Activating.....	33
Deactivating.....	33
Appliance disposal.....	48
Appliance door.....	9
Cleaning.....	38
Setting the door weight.....	8
Automatic.....	13
Automatic door opener.....	36
Automatic stand-by.....	37
B	
Brightness.....	35
Button tone.....	35
C	
Cancelling	
Button.....	11
Delayed start.....	28
Celsius.....	36
Childproof lock.....	15
Activating.....	32
Deactivating.....	33
Unlocking.....	32
Combination cleaning products.....	22
All in 1.....	15
Consumption values.....	13
Cup support.....	45
Cutlery	
Large cutlery basket.....	9, 45
Loading.....	17
Small cutlery basket.....	45
Vario cutlery basket insert.....	45
D	
Declaration programme.....	13
Delayed start.....	14
Cancelling.....	28
Setting duration.....	28
Demo mode.....	43
Detergent	
Adding.....	23
Combination.....	15
Selecting.....	22
Detergent dispenser.....	9, 23
Display.....	9
Operating.....	24
Unlocking.....	32
Wipe protection.....	15
Disposal.....	48
Door handle.....	9
DryPlus.....	14
E	
Easy care	
Energy saving.....	14
Glass.....	14
Easy prongs.....	16, 18, 45
Eco.....	13
Energy saving.....	14
F	
F and E messages.....	41, 42
Factory settings.....	37
Fahrenheit.....	36
Favourites.....	30
Creating.....	30
Deleting all.....	37
Deleting individual.....	24, 31
Saving.....	24
Starting.....	30
Using in permanent mode.....	31
Filter system.....	9, 46
Cleaning.....	39
French degree of water hardness.....	36
FunctionLight.....	9, 11
Activating.....	36
Deactivating.....	36
G	
German degree of water hardness.....	36
Glasses	
Energy saving.....	14
Glass.....	14
Glass holder.....	19
Loading.....	16, 18, 19
Lower basket for glasses.....	45
H	
Hot water connection.....	37
I	
Identification plate.....	51
Information.....	24, 33
Intensive.....	14
Interior.....	9
Cleaning.....	38
L	
Language.....	35

LED.....	11	Automatic.....	13
Loudness.....	35	Intensive.....	14
Lower basket.....	9	Soiling, light	
Loading.....	16	Automatic.....	13
M		Quick.....	14
Model designation.....	2	Soiling, normal	
Model number.....	2	Automatic.....	13
O		Eco.....	13
Operating and display elements.....	9	Spray arms.....	9
		Cleaning.....	38
		Symbols.....	4
P		T	
Permanent mode.....	24, 29	Tabs.....	22, 23
Powder.....	23	Temperature unit.....	36
Pre-rinsing.....	14	Tone.....	35
Product fiche.....	47	Type.....	2
Programme.....	10, 13	U	
Aborting.....	26	U and E messages.....	42
Duration.....	13	Upper basket.....	9
End.....	27	User settings.....	10, 35
Interrupting.....	26	Adjusting.....	35
Selecting.....	25	Initial set-up.....	8
Starting.....	25, 30	V	
Using in permanent mode.....	29	Validity.....	2
Q		Vario cutlery basket insert.....	45
Queries.....	51	V-ZUG App.....	34
Quick programmes		V-ZUG-Home	
Quick.....	14	Activating.....	37
R		W	
Rack.....	19, 45	Water hardness.....	36
Regeneration salt		Regeneration salt.....	40
Consumption.....	40	Wipe protection.....	15
Refilling.....	39	Activating.....	33
Rinse agent		WLAN connection.....	34
Adding.....	40		
Dosing.....	36		
Rinse agent reservoir.....	9, 40		
RinsePlus.....	14		
S			
Safety warnings			
General.....	4		
Salt reservoir.....	9, 39		
Serial number (SN).....	51		
Service & Support.....	51		
Service agreement.....	51		
Service settings.....	37		
Setting options.....	10, 14		
Adding to favourites.....	30		
Selecting permanent.....	31, 35		
Turning off temporarily.....	32		
Soiling, heavy			

15 Service & Support



The «Trouble-shooting» section gives you valuable tips on how to deal with minor malfunctions yourself, saving you the time and trouble of calling out a service technician and any cost that goes along with it.

Information on the V-ZUG warranty can be found at www.vzug.com →Service →Warranty information. Please read this information carefully.

Please register your V-ZUG appliance straightaway:

- online at www.vzug.com →Service →Online warranty registration or
- using the enclosed registration card.

This will allow you to take advantage of the best possible support in the event of a fault in the appliance during the guarantee period. You will require the serial number (SN) and appliance designation to register your appliance. You will find them on the identification plate of your appliance.

My appliance information:

SN: _____ **Appliance:** _____

Please have this appliance information to hand when contacting V-ZUG. Thank you.

- ▶ Open the appliance door.
 - The identification plate is located on the left-hand side on edge of the tub.

Your repair order

Call the free service number 0800 850 850 to contact your nearest V-ZUG service centre. You can arrange an on-site visit by us by phone if you wish.

General queries, accessories and service agreement

V-ZUG will be happy to help you with any general administrative or technical queries, to accept your orders for accessories and spare parts and to inform you about our progressive service agreements. You can contact us by calling tel. +41 58 767 67 67 or by going to our website at www.vzug.com.

Quick start guide

Open appliance door



Load dishes

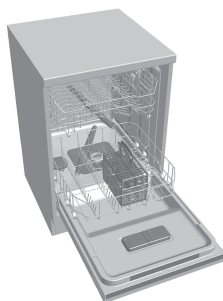

Add detergent

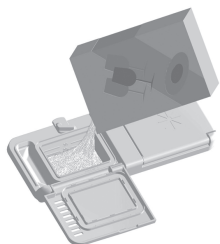

Select programme



Close appliance door:
programme starts

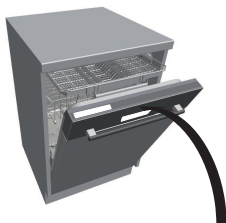

At end of final drying:
unload dishes

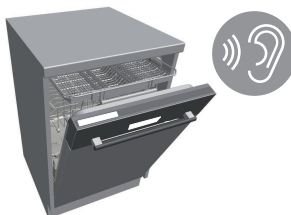

1065806-R03

