

Operating instructions

AdoraDry V2000

Tumble dryer

Thank you for choosing to buy one of our products. Your appliance is made to high standards and is easy to use. Nevertheless, please take the time to read these operating instructions in order to familiarize yourself with the appliance and get the best use out of it.

Please follow the safety precautions.

Modifications

Text, diagrams and data correspond to the technical standard of the appliance at the time these operating instructions went to press. The right to make technical modifications for the purpose of the further development of the appliances is reserved.

Validity

The model number corresponds to the first alphanumeric characters on the identification plate. These operating instructions apply to:

Model designation	Model number	Type
AdoraDry V2000	12011	AT2TWHWL, AT2TWHWR

Variations depending on the model are noted in the text.

Contents

1	Safety warnings	5	6.4	Starting favourites.....	20
1.1	Symbols used.....	5	7	V-ZUG-Home	21
1.2	General safety precautions.....	5	7.1	Conditions.....	21
1.3	Appliance-specific safety precautions.....	5	7.2	Initial set-up.....	21
1.4	Instructions for use.....	7	8	User settings	22
2	Initial set-up	9	8.1	Customizing user settings.....	22
3	Appliance description	9	8.2	Brightness.....	22
3.1	Construction.....	9	8.3	Button tone.....	22
3.2	Operating and display elements.....	10	8.4	Viewing angle.....	22
3.3	Indicator lights.....	10	8.5	Language.....	22
3.4	Button state.....	11	8.6	Background image.....	23
4	Programme overview	11	8.7	Level of dryness.....	23
4.1	Automatic programmes.....	11	8.8	ReversePlus.....	23
4.2	Timed drying.....	11	8.9	EcoManagement.....	23
4.3	Textile programmes.....	11	8.10	Childproof lock.....	23
4.4	Standard and extra programmes.....	12	8.11	Drum illumination.....	23
4.5	Additional functions.....	12	8.12	V-ZUG-Home.....	23
4.6	EcoManagement.....	13	8.13	Factory settings.....	24
4.7	Phases.....	13	9	Demo mode	24
4.8	Duration remaining indicator.....	13	9.1	Switching on.....	24
5	Operating the appliance	14	9.2	Switching off.....	24
5.1	Preparations.....	14	10	Care and maintenance	25
5.2	Selecting a programme.....	14	10.1	Cleaning intervals.....	25
5.3	Selecting additional functions.....	16	10.2	Cleaning the door filter and door filter mat.....	25
5.4	Checking and changing the settings.....	16	10.3	Cleaning the front filter mat.....	26
5.5	Adding washing.....	17	10.4	Cleaning the moisture sensor.....	26
5.6	Interrupting a programme.....	17	10.5	Cleaning the temperature sensor.....	27
5.7	Ending a programme before time.....	17	10.6	Cleaning the appliance.....	27
5.8	With childproof lock activated.....	17	11	Trouble-shooting	27
5.9	Drum illumination.....	18	11.1	Error messages.....	27
5.10	End of programme.....	18	11.2	Other possible problems.....	29
5.11	EcoManagement.....	18	12	Spare parts	31
6	Favourites	19	13	Technical data	31
6.1	Defining favourites.....	19	13.1	Note for testing institutes.....	32
6.2	Changing favourites.....	20	13.2	Product fiche.....	32
6.3	Deleting favourites.....	20	13.3	Consumption values.....	33

14	Drying tips	34
14.1	Saving energy.....	34
14.2	Avoiding damage	34
15	Disposal	35
	Index	36
16	Notes	38
17	Service & Support	39

1 Safety warnings

1.1 Symbols used



Denotes important safety precautions.

Failure to observe said precautions can result in injury or in damage to the appliance or fittings!



Information and precautions that should be observed.



Information on disposal



Information about the Operating Instructions

- ▶ Indicates step-by-step instructions.
 - Describes how the appliance reacts to the steps taken.
- Indicates a list.

1.2 General safety precautions



- Read the operating instructions before using the appliance for the first time!



- This appliance can be used by children aged 8 and above and by persons with reduced physical, sensory or mental capabilities, or lack of experience and/or knowledge, provided they are supervised or have been instructed on the safe use of the appliance and have understood the hazards involved. Children shall not play with the appliance.

Cleaning and user maintenance shall not be undertaken by children without supervision.

- If an appliance is not equipped with a mains cable and a plug or other means for disconnecting from the mains with a contact opening on each pole complying with the conditions of overvoltage category III for full isolation, an isolating device must be incorporated into the permanently installed electrical installation in accordance with the installation regulations.
- If the mains cable of this appliance is damaged, it must be replaced by the manufacturer or its Customer Services or a similarly qualified person in order to avoid hazard.

1.3 Appliance-specific safety precautions

- Children under 3 years of age must be kept away from the appliance unless they are continuously supervised.
- The appliance has a maximum dry load capacity of 7 kg.

- **WARNING:** This appliance is only designed for drying textiles which have been washed in water.
- The appliance is only to be used with the recommended vaporizing medium. The use of other substances may give rise to a toxic or fire risk.
- The appliance has hot surfaces to evaporate active components. These surfaces should not be touched during use.
- The tumble dryer may not be used if industrial chemicals were used for cleaning.
- Clean the fluff filters regularly.
- Do not allow fluff to build up around the tumble dryer.
- Do not dry unwashed items in the tumble dryer.
- Textiles that have been cleaned, treated or soaked with flammable chemicals, detergents or solvents (such as white spirit, alcohol, stain remover, oil, edible oil, turpentine, acetone, paint, wax, etc.) are a fire and explosion hazard! Wash materials containing such substances first by hand with water or allow the solvent to evaporate completely.
- Items such as foam rubber (latex foam), shower caps, waterproof textiles, rubber backed articles and clothes or pillows fitted with foam rubber pads should not be dried in the tumble dryer.
- Remove objects such as lighters and matches and the like.
- **WARNING:** Never stop a tumble dryer before the end of the drying cycle unless all items are quickly removed and spread out so that the heat is dissipated.
- Ensure that any ventilation openings in the base of the appliance are not obstructed by carpet.
- **WARNING:** If the appliance is installed in a housing, the ventilation openings are to be kept free of obstruction.
- Exhaust air must not be discharged into a flue which is used for exhausting fumes from appliances burning gas or other fuels.
- Fabric conditioner (softener) and similar products must be used as per the manufacturer's instructions.

- Do not install the appliance behind a door that locks, a sliding door or a door with a hinge that lies opposite the hinge of the appliance.

1.4 Instructions for use

Before using for the first time

- The appliance must be installed and connected to the electricity supply in accordance with the separate installation instructions. Have a qualified fitter/ electrician carry out the necessary work.
- Ensure access to the place of disconnection (e.g. socket outlet, wall switch, fuse) and the water tap.

Correct use

- The appliance is only suitable for drying home textiles. It is designed for use in the home and for the above-mentioned purpose only. No liability is assumed for any damage caused by improper or incorrect use.
- Any repairs, modifications or manipulations to the appliance, especially any electrically live parts, may only be carried out by the manufacturer, its customer service department or similarly qualified persons. Repairs if carried out incorrectly may cause serious injury, damage to the appliance and fittings, as well as affect the functioning of the appliance.
- If the appliance is not working properly or in case a repair is needed, follow the instructions given in the «Service and repairs» section. Please contact our Customer Services if necessary.
- Use original spare parts only.
- Before closing the appliance door and starting a programme, ensure that there are no foreign objects or pets in the drum.

Note on use

- If the appliance is not functioning properly, disconnect it from the power supply immediately.
- To protect your washing, follow the fabric care symbols and the hints and advice in the «Programme overview» section.
- Do not operate the appliance without a door filter or with a damaged door filter. Fluff can destroy the appliance!

Caution: Risk of burns!

- Do not dry fabrics that contain traces of hair spray, hair gel, nail varnish remover or other similar substances. Danger of gas build-up!

Caution: Risk to life!

- Packaging material, e.g. plastic film and polystyrene, can be dangerous for children. Danger of suffocation! Keep packaging material away from children.
- When carrying out maintenance work on the appliance, including replacing light bulbs, cut off the electricity supply to the appliance: remove the screw fuse from the holder or switch the circuit breaker off, or unplug from the mains socket.

How to avoid damaging the appliance

- Close the appliance door carefully.
- When cleaning the appliance make sure no water gets inside it. Use a moderately damp cloth. Do not spray the outside or the inside of the appliance with water. If water gets inside the appliance, it will cause damage.

Transport and installation

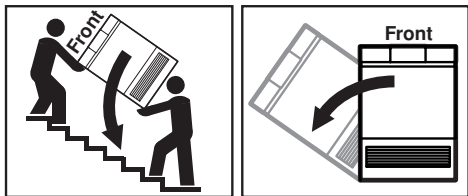

Tilt max. 90° to the left!

- Transport the appliance in an upright position only! Transporting it in any other position will result in damage to the appliance! When carried carefully without being shaken, the appliance may be tilted a maximum of 90° to the left (viewed from the front).
- As a general rule, rooms containing heat pump dryers should be ventilated as these produce a small amount of moisture. If the room is kept closed, it must be aired occasionally (either by opening the door to the room or a window) between several consecutive drying programmes.

2 Initial set-up



The appliance must be installed and connected to the electricity supply in accordance with the separate installation instructions. Have a qualified fitter/electrician carry out the necessary work.



If the location of the appliance is changed, because of the heat pump it must stand in its final position for around 2 hours before it can be operated again. Failure to do this can result in damage to the appliance.

3 Appliance description

3.1 Construction

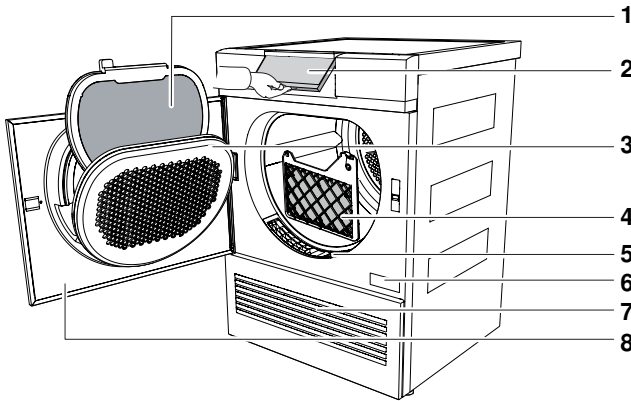

1 Door filter with door filter mat

2 Operating panel (pivoting)

3 Cover for door filter

4 Front filter mat

5 Front grille

6 Identification plate / Serial number (SN)

7 Ventilation grille

8 Appliance door

3.2 Operating and display elements

Operating panel

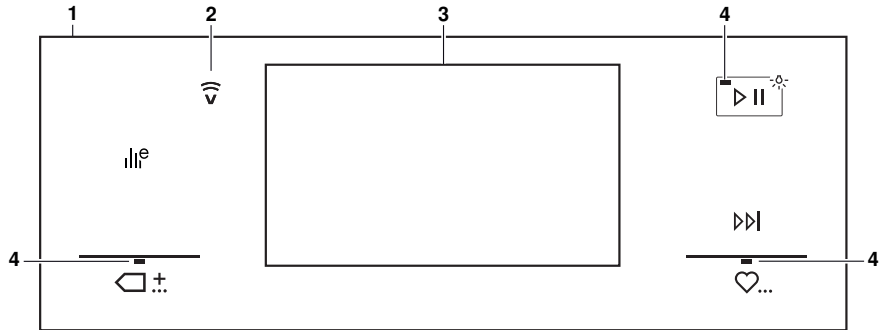

- 1 Operating panel
- 2 V-ZUG-Home display
- 3 TouchDisplay
- 4 Indicator light

Buttons

- EcoManagement
- Standard and extra programmes
- Start/Pause/Drum illumination
- End of programme
- Favourites

TouchDisplay

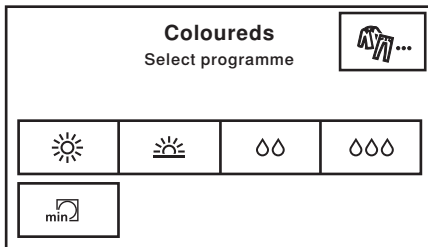

Buttons

- Textile programmes
- Extra dry
- Normal dry
- Iron dry
- Damp
- Timed drying

3.3 Indicator lights

Indicator light	Activity	State
	Indicator light is illuminated.	Function is active.
	Indicator light is flashing.	Function is selectable.
	Indicator light is not illuminated.	Function is not selectable.



3.4 Button state

Background colour	Symbol colour	State
Blue	White	Function is active.
Black	White	Function is selectable.
Black	Black	Function is not selectable.

4 Programme overview

All the programmes are described below.

4.1 Automatic programmes

Programmes	Load capacity
 Extra dry: For thick, multi-layered textiles and mixed loads. Less suitable for knitted or woven articles (e.g. t-shirts or underwear).	1–7 kg
 Normal dry: For similar items of washing (e.g. t-shirts or underwear).	1–7 kg
∞∞ Iron dry: For items that are to be ironed.	1–7 kg
∞∞∞ Damp: For items that are to be pressed in a mangle (e.g. table linen).	1–7 kg

4.2 Timed drying

Programme	Load capacity
 Timed drying: Dries textiles for a set duration, irrespective of their level of dryness. For final drying of sleeping bags and quilts, provided they have the relevant fabric care symbols. Load for bulky textiles: 1 item	1–7 kg

4.3 Textile programmes



Touch the  button for the selection of textile programmes.

Programmes	Load capacity
1/2 Coloureds: Automatic programmes suitable for most textiles.	1–7 kg
Shirts: Fabrics are gently dried to «Standard dry».	max. 7 items
Denim: Denim fabrics are dried to «Standard dry». Follow the fabric care symbols as denim material can shrink.	1–4 kg
Silks: For drying silk fabrics. Follow the fabric care symbols as silk tends to crease easily. Low temperature for gentle drying.	1–1.5 kg

Programmes	Load capacity
2/2 Baby garments: Baby garments are gently dried to «Standard dry». The washing is dried hygienically through an extended final drying phase.	1–5 kg



4.4 Standard and extra programmes

Touch the  button for the selection of standard and extra programmes.

Programmes	Load capacity
 Standard programme: The most efficient programme for drying normal wet cotton laundry.	1–7 kg
 Basket programme: For drying clean canvas shoes/trainers and small items such as gloves, hats and soft toys in the basket (can be ordered as an accessory). Not suitable for leather or synthetic leather.	
 Airing: For refreshing or airing little-worn garments.	1–1.5 kg

4.5 Additional functions

Whenever a programme is selected, the selectable additional functions are displayed.

Additional functions	Load capacity
 Easy care: Gentle drying for mixed fabrics (e.g. shirts, pullovers and t-shirts). The level of dryness is reduced. To prevent creasing, put only a few items of laundry in the washing drum and unload them as soon as the programme ends.	1–2.5 kg
 ReversePlus: The washing is dried evenly and less likely to get tangled. Particularly suitable for drying larger items, e.g. bedding.	
 Delayed start: For using cheap-rate electricity (setting range of up to 24 hours). The programme starts automatically when the delayed start set is reached.	

4.6 EcoManagement

Button

 Only active if «EcoManagement» is turned on in the user settings (see page 23). EcoManagement provides information on the energy consumption of the appliance. The following statistical data can only be retrieved when no programme is running (see page 18):

- Energy consumption of the last programme
- Total energy consumption
- Average energy consumption of the last 25 programmes

The energy consumption of a programme is displayed during programme selection.

At the end of a programme, the energy consumption of the programme that has just ended is displayed.

The values can vary according to programme, load, additional functions, user settings, initial level of moisture in the laundry and ambient temperature.

4.7 Phases

The drying process has 3 phases:

Phases

Drying: The laundry is dried as per the settings (programme selection and user settings).

Cooling down / Final airing: The laundry is cooled down to a temperature at which the risk of creasing is minimized. The duration of this phase depends on the temperature of the laundry. «Crease guard» starts if the appliance is not unloaded when this phase ends.

Crease guard: The dried laundry is moved at frequent intervals for up to 30 minutes to prevent creasing. Open the appliance door to end before time.

4.8 Duration remaining indicator

When the programme starts, the programme duration at maximum load is displayed. The actual load is determined and the expected duration remaining is calculated, which takes about 1 minute. The letter «h» flashes and «Determining load» appears in the display. The expected duration remaining is subsequently displayed.

The programme may possibly take longer than initially calculated. In this case, the duration remaining freezes while the programme runs. The letter «h» flashes again and «Calculating time remaining» appears in the display.

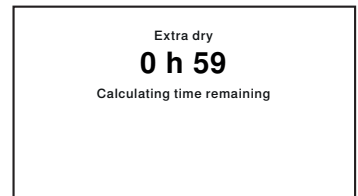

5 Operating the appliance

5.1 Preparations

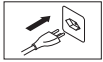

- ▶ Insert the mains plug into a mains socket.

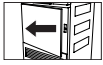

- ▶ Press the 5 dots at the edge of the appliance door.
 - The appliance door opens.
 - The drum illumination switches on.



- ▶ Loosely load wet laundry items one by one into the appliance.

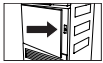

- ▶ Close the appliance door.
- ▶ Ensure that no items of laundry are trapped in the appliance door.
 - The drum illumination switches off.
 - The start screen appears.

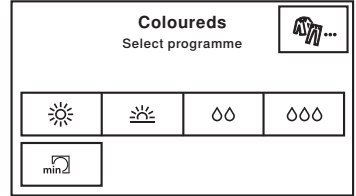

If no programme selection is made within 5 minutes, all the displays go out. Touch the  button at any time to display the start screen again.

5.2 Selecting a programme



To avoid damaging the laundry, follow the fabric care symbols on garment labels:



Tumble dry, medium heat



Tumble dry, low heat



Do not tumble dry

Automatic programmes

When a programme is selected, all the necessary settings for it are assigned automatically. Additional functions can be selected or deselected by using further buttons in other views.



- ▶ Touch the button for the desired programme.
 - The programme selected, the expected duration and the selectable additional functions are displayed.



- ▶ Touch the button.
 - The programme selected starts.

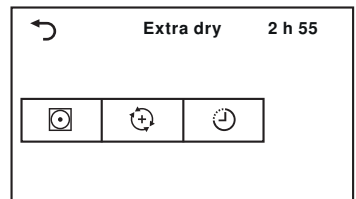

Timed drying

- ▶ Touch the button.
 - A selection of drying times appears in the TouchDisplay.
- ▶ Select the desired drying time.
 - The programme selected and all selectable additional functions appear.
- ▶ Touch the button.
 - The programme selected starts.

Timed drying			
Duration in minutes			
10	20	30	40
50	60	90	120

Textile programmes

- ▶ Touch the button.
 - The selection of textile programmes appears in the TouchDisplay.
- ▶ Touch the button repeatedly until the desired textile programme is displayed.
- ▶ Touch the button for the desired textile programme.
 - The programme selected and all selectable additional functions are displayed.
- ▶ Touch the button.
 - The programme selected starts.



Textile programmes	
Coloureds	Shirts
Denim	Silks

Standard and extra programmes

- ▶ Touch the button.
 - A selection of standard and extra programmes appears in the TouchDisplay.
- ▶ Touch the button for the desired standard or extra programme.
 - The programme selected and all selectable additional functions are displayed.
- ▶ Touch the button.
 - The programme selected starts.



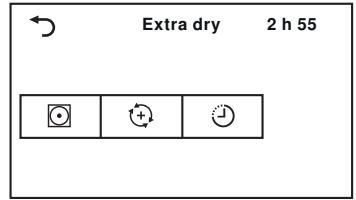

Extra	
Standard	Basket
	Airing

5.3 Selecting additional functions

- ▶  Touch the button for the desired programme.
 - The programme selected and all selectable additional functions are displayed.
- ▶  For desired additional functions, touch the corresponding buttons.
 - The new programme duration is displayed.
- ▶  Touch the button.
 - The programme selected starts.

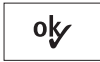

Setting a delayed start

- ▶  Touch the button.
 - The input field for the time delay to the start of the programme appears in the TouchDisplay.
- ▶  Enter the desired time delay to the start of the programme.
- ▶  Touch the button.
 - The time delay to the start of the programme is saved.
- ▶  Touch the button.
 - The delayed start time starts. The desired programme starts automatically when the time delay set is up.

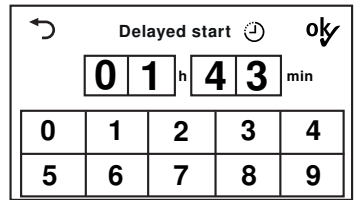

5.4 Checking and changing the settings

- ▶  Touch the button in the «Additional functions» view.
 - The start screen appears.
- ▶ Select a new programme (see page 14).
- ▶ To make a change once a programme has started, the programme must be ended before time (see page 17).

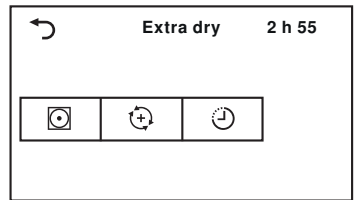

5.5 Adding washing

Washing can be added at any time during the drying process.



- ▶ Press the 5 dots at the edge of the appliance door.
 - The appliance door opens.
 - Laundry can be added.

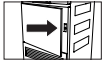

- ▶ Close the appliance door.
 - In the TouchDisplay appears: «Continue with button »



- ▶ Touch the button.
 - The programme is resumed.

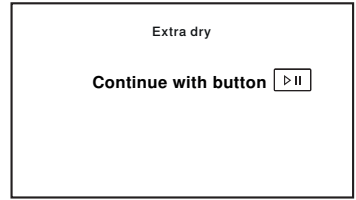

5.6 Interrupting a programme



- ▶ Touch the button.
 - In the TouchDisplay appears: «Pause
 - Continue with button »
 - The programme is interrupted.



- ▶ Touch the button again.
 - The programme is resumed.

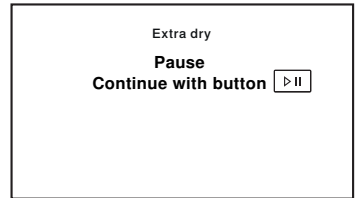

Each time a programme is interrupted, the programme sequence is delayed by 5 minutes.

5.7 Ending a programme before time



- ▶ Touch the button.
 - The programme is aborted.
 - All settings are cleared.

5.8 With childproof lock activated

How to turn the childproof lock on/off is described in «User settings».

When the childproof lock is activated, the appliance can no longer be operated once a programme has started or if no button has been touched for over 20 seconds. A code must be entered to unlock the appliance.

- ▶ When the childproof lock is activated, touch any button on the TouchDisplay.
 - The input field for the code appears in the TouchDisplay.

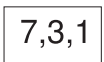

- ▶ Touch the digits 7, 3, 1 in sequence.



- ▶ Touch the button.
 - The appliance is unlocked.

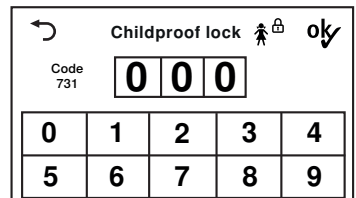

After being unlocked, the appliance can be operated normally. The childproof lock is automatically activated as soon as the programme starts.

5.9 Drum illumination

The drum illumination automatically switches on whenever the appliance door is opened and switches off when it is closed. If the appliance door is left open, the drum illumination switches off automatically within 2 minutes.



- ▶ Touch the button to switch the drum illumination on or off when the appliance door is open.



If the appliance door is opened during or at the end of the standard programme, the drum illumination does not switch on automatically because this is the most energy-efficient programme and the energy requirements are reduced to a minimum (see page 33).

5.10 End of programme

Unloading the washing

When the programme has finished,

- «0h00» appears in the TouchDisplay
- information on the energy consumption (see page 19) appears in the TouchDisplay, provided «EcoManagement» has been turned on in the user settings (see page 23).



Unload the laundry as soon as the programme ends to prevent creasing. Crease guard starts if the appliance is not unloaded straightaway (see page 11). When it has finished, all the displays go out.



- ▶ Press the 5 dots at the edge of the appliance door.
 - The appliance door opens.
 - The drum illumination switches on.
 - All the displays go out.



- ▶ Unload the laundry.

Each time after use



- ▶ Clean the door filter (see page 25).



- ▶ Close the appliance door.
 - The drum illumination switches off.

5.11 EcoManagement

Only active if «EcoManagement» is turned on in the user settings (see page 23).

Displaying estimate during programme selection

The expected energy consumption can be displayed during additional function selection.



- ▶ Touch the desired programme.
 - The programme selected with the expected energy consumption appears in the TouchDisplay.



Displaying last programme

The energy consumption of the last programme can be displayed if no programme is running.

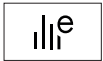

- ▶ Touch the button.
 - The energy consumption of the last programme run is displayed.



- ▶ Touch the button to end statistic retrieval.

Last programme
Consumption values 0.9 kWh

Displaying total and average consumption

Total and average consumption can be displayed if no programme is running.



- ▶ Hold the button depressed for 3 seconds.
 - Total and average consumption are displayed.



- ▶ Touch the button to end statistic retrieval.

EcoManagement Statistics
Total 390 kWh Average 0.9 kWh

6 Favourites

Simple start to frequently used programmes.



The appliance door has to be open to define, change or delete a favourite.

6.1 Defining favourites



- ▶ Press the 5 dots at the edge of the appliance door.
 - The appliance door opens.



- ▶ Touch the button.

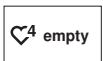

- ▶ Touch one of the favourite buttons.



- ▶ Select programme and additional functions.



- ▶ Touch the button.



- ▶ Touch the button to save the favourite programme.

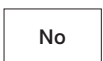

- ▶ Touch the button to cancel the action.

6.2 Changing favourites



- ▶ Press the 5 dots at the edge of the appliance door.
 - The appliance door opens.



- ▶ Touch the button.

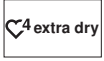

- ▶ Touch the favourite programme to be changed.



- ▶ Touch the button.
- ▶ Make the changes.



- ▶ Touch the button.

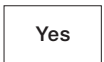

- ▶ Touch the button to save the favourite programme.

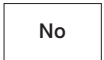

- ▶ Touch the button to cancel the action.

6.3 Deleting favourites



- ▶ Press the 5 dots at the edge of the appliance door.
 - The appliance door opens.



- ▶ Touch the button.

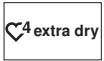

- ▶ Touch the favourite programme to be deleted.

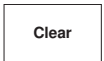

- ▶ Touch the button.
 - The favourite programme is cleared.

6.4 Starting favourites



- ▶ Close the appliance door.



- ▶ Touch the button.

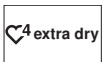

- ▶ Touch the desired favourite programme.



- ▶ Touch the button.
 - The programme selected starts.

7 V-ZUG-Home

7.1 Conditions

The following conditions must be met for full use of V-ZUG-Home:

- Access to the internet and to Google Play™ Store / App Store®
- a wireless network that meets one of the following standards: 2.4GHz 802.11 b/g/n
- Smartphone or tablet that is connected to the wireless network
- System requirements for smartphone or tablet: from Android 6.0 or from iOS 11.0



Google Play™ is a trademark of Google Inc.



Apple and the Apple logo are trademarks of Apple Inc., registered in the U.S. and other countries. App Store® is a service mark of Apple Inc.

7.2 Initial set-up

- ▶ Set to the «Display» or «Operate and display» mode under «V-ZUG-Home» in the user settings.
- ▶ Enable Bluetooth on the smartphone or tablet.
- ▶ Search the Google Play™ Store or the App Store® for «V-ZUG».
- ▶ Install and open the V-ZUG App.
- ▶ In the V-ZUG App, add the appliance.
- ▶ Press +.
 - A 6-digit PIN appears in the display of the appliance.
- ▶ Enter the 6-digit PIN in the app.
 - All available wireless networks appear in the app.
- ▶ Select a wireless network.
- ▶ Enter the password for the wireless network.
 - The appliance is connected to the wireless network.



Further information can be found in the V-ZUG-Home operating instructions or on home.vzug.com.

8 User settings



Providing no programme is running and no error messages are displayed, the user settings can be changed.

8.1 Customizing user settings

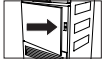

▶ Close the appliance door.



▶ Touch the button.
– The «Extra» menu appears in the TouchDisplay.



▶ Touch the button.
▶ Select and change desired settings and submenus.



▶ Touch the button to save the selected setting.

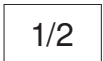

▶ Touch the button to select and change any other settings.



▶ Touch the button to exit user settings.

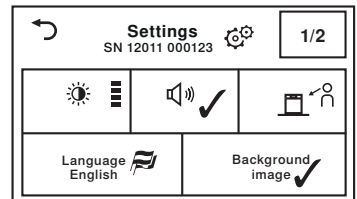
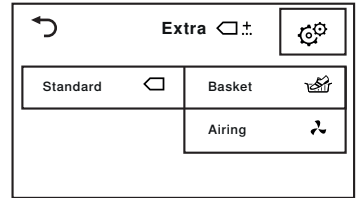



8.2 Brightness

The display can be adjusted to the prevailing light conditions.

- Dark
- Medium bright
- Bright (factory setting)
- Very bright



8.3 Button tone

The button tone can be turned on and off. The button tone for the  and  buttons cannot be turned off.

- On (factory setting)
- Off

8.4 Viewing angle

The readability of the TouchDisplay is improved when viewed from below at an angle.

- : TouchDisplay viewed from above (factory setting)
- : TouchDisplay viewed from below

8.5 Language

The language is set during the initial set-up of the appliance. It can be changed.

- German
- ...

8.6 Background image

The background image of the TouchDisplay can be turned off. In this case, the background appears black.

- On (factory setting)
- Off

8.7 Level of dryness

Change the level of dryness if the washing is not being dried sufficiently or is being overdried. The new level of dryness applies to all programmes. A low level of dryness (low final drying) is recommended for very hard water and a high level of dryness (strong final drying) for very soft water.

- For very hard water
- For hard water
- For normal water (factory setting)
- For soft water
- For very soft water



Risk of overdrying!

Overdrying can weaken fabrics.

8.8 ReversePlus

When this function is activated, the washing dries evenly and is less likely to get tangled.

- On
- Off (factory setting)

8.9 EcoManagement

When this function is activated, the estimated consumption values appear at the start of the programme and the actual consumption values appear at the end of the programme. The saved consumption values can be deleted under «Statistics».

- On (factory setting)
- Off
- Statistics
- Information

8.10 Childproof lock

The childproof lock prevents a programme from being started accidentally. The appliance can only be operated after first entering the code 731 (see page 17).

- On
- Off (factory setting)

8.11 Drum illumination

When this function is activated, the drum illumination automatically switches on whenever the appliance door is opened and switches off whenever it is closed.

- On (factory setting)
- Off

8.12 V-ZUG-Home

With V-ZUG-Home (see page 21), you can access your appliances over the V-ZUG App to, for instance

- switch off a running appliance
- call up the status of your household appliances.

- Operate and display
- Display
- Off (factory setting)



Further information can be found in the V-ZUG-Home operating instructions or on home.vzug.com.

8.13 Factory settings

The factory settings can be restored. The language if changed is not reset to the factory setting.

- **ok**: Restore
- ↶: Do not restore



Any favourites that have been saved will also be deleted.

9 Demo mode

In the demo mode, almost all the appliance functions are available but it is not possible to dry with the appliance.



The demo mode can only be switched on or off when the appliance door is open.

9.1 Switching on



- ▶ Press the 5 dots at the edge of the appliance door.
 - The appliance door opens.



- ▶ Simultaneously depress the buttons for 5 seconds until the «Demo mode» menu appears in the TouchDisplay.



- ▶ Touch the button.
 - The demo mode is deselected.

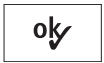

- ▶ Touch the button.
 - The setting is saved.
 - The TouchDisplay goes dark.

9.2 Switching off

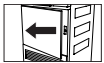

- ▶ Press the 5 dots at the edge of the appliance door.
 - The appliance door opens.

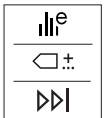

- ▶ Hold the buttons depressed at the same time.
 - The «Demo mode» menu appears in the TouchDisplay.



- ▶ Touch the button.
 - The demo mode is not selected.



- ▶ Touch the button.
 - The setting is saved.
 - The TouchDisplay goes dark.

10 Care and maintenance

A thick coating of fluff can trigger the «A9 Clean filter and mats» (see page 27) error message.

10.1 Cleaning intervals

Appliance part	Cleaning interval
Door filter	<ul style="list-style-type: none"> ▪ After each use ▪ When prompted «A9 Clean filter and mats»
Door filter mat	<ul style="list-style-type: none"> ▪ When prompted «A9 Clean filter and mats» ▪ As required
Front filter mat	<ul style="list-style-type: none"> ▪ When prompted «A9 Clean filter and mats» ▪ 1× per year
Moisture sensor	<ul style="list-style-type: none"> ▪ When prompted «A3 Clean moisture sensor»
Temperature sensor	<ul style="list-style-type: none"> ▪ As required
Cleaning the exterior	<ul style="list-style-type: none"> ▪ As required

10.2 Cleaning the door filter and door filter mat

Cleaning the door filter

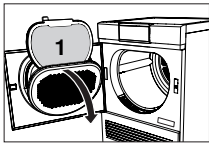

- ▶ Open appliance door and then open cover for door filter.
- ▶ Take out the door filter **1** and remove the fluff.
- ▶ Put back the door filter **1**.
- ▶ Close cover for door filter and close appliance door.

Cleaning the door filter and door filter mat

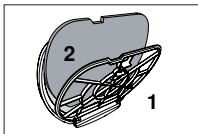

- ▶ Take out the door filter **1**, as described in «Cleaning the door filter».
- ▶ Open the door filter **1** and take out the door filter mat **2**.

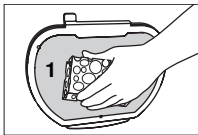

- ▶ Hold the door filter **1** up to the light to detect deposits. Clean the door filter **1** if necessary (with water, the soft side of a sponge and abrasive liquid cleaning agent or cleaning vinegar).



- ▶ Wash the door filter mat **2** under running water or in a washing machine at 40 °C.



Vacuum cleaning can cause damage to the appliance!

Never clean the door filter mat with a vacuum cleaner!

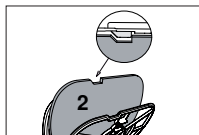

- ▶ Put the dry door filter mat **2** back into the door filter **1**.
- ▶ Put back the dry door filter **1**.



Ensure the door filter is positioned correctly.

10.3 Cleaning the front filter mat

If the «A9 Clean filter and mats» error message still appears after the door filter and the door filter mat have been cleaned, the front filter mat must also be carefully cleaned.

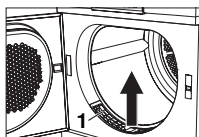

- ▶ Open the appliance door and remove the front grille **1**.

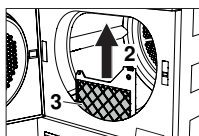

- ▶ Press the lug **2** down slightly to release and remove the front filter mat **3**.

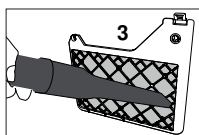

- ▶ Clean the front filter mat **3** carefully using a vacuum cleaner with the crevice tool attachment.
- ▶ Clean the air duct in front of the front filter mat with a vacuum cleaner or moist cloth if necessary.
- ▶ Put back the front filter mat **3** and engage. Ensure it is positioned correctly.
- ▶ Put back the front grille **1**.



An incorrectly inserted front filter mat can cause damage to the appliance.

The appliance will not start without the front filter mat being correctly in place.

10.4 Cleaning the moisture sensor

If the «A3» error message appears, the moisture sensor must be cleaned.

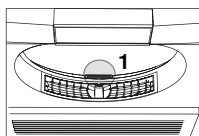

- ▶ Open appliance door.

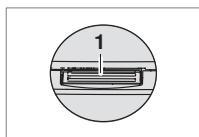

- ▶ Remove any fluff or foreign objects on the moisture sensor **1**.
- ▶ If necessary, clean moisture sensor **1** with a damp cloth and wipe dry.

10.5 Cleaning the temperature sensor



Carefully clean the temperature sensor!

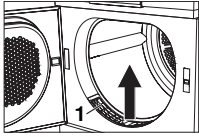

- ▶ Open the appliance door and remove the front grille **1**.

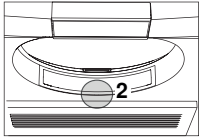

- ▶ Clean the temperature sensor **2** with a damp cloth.
- ▶ Put back the front grille **1**.

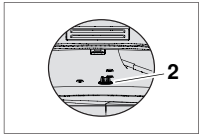

10.6 Cleaning the appliance

- ▶ Wipe the outside of the appliance from time to time with a damp cloth and wipe dry.

11 Trouble-shooting



You may be able to trouble-shoot the following malfunctions yourself. If not, note down the error message in full (message, F and E numbers) and call Customer Services.





11.1 Error messages

Display	Possible cause	Solution
A0 Check outlet	<ul style="list-style-type: none"> ▪ The drain hose is blocked, kinked or defective. ▪ The pumping height of the drain hose is too high (>1.2 m). ▪ The appliance is connected to a concealed double drain trap. 	<ul style="list-style-type: none"> ▶ Check part of drain hose that is not housed in appliance. ▶ Press the ▶▶ button. ▶ Restart the programme.
A3 Clean moisture sensor	<ul style="list-style-type: none"> ▪ The moisture sensor is dirty or wet. 	<ul style="list-style-type: none"> ▶ Clean moisture sensor and then wipe dry (see page 26). ▶ Press the ▶▶ button. ▶ Restart the programme.

Display	Possible cause	Solution
A9 Clean filter and mats	<ul style="list-style-type: none"> ▪ Door filter, door filter mat and/or front filter mat are clogged. 	<ul style="list-style-type: none"> ▶ Check and clean door filter and door filter mat (see page 25). ▶ Check and clean the front filter mat (see page 26). ▶ Press the ▶▶ button. ▶ Restart the programme.
Insert door filter / close appliance door	<ul style="list-style-type: none"> ▪ The door filter is missing. ▪ The appliance door is open. 	<ul style="list-style-type: none"> ▶ Insert door filter (ensure it is positioned correctly). ▶ Close the appliance door. ▶ Restart the programme.
Insert front mat	<ul style="list-style-type: none"> ▪ The front filter mat is not inserted correctly. 	<ul style="list-style-type: none"> ▶ Insert front filter mat correctly. ▶ Close the appliance door. ▶ Restart the programme.
FXX/EXX see instructions SN XXXXX XXXXXX	<ul style="list-style-type: none"> ▪ Various situations can lead to this error message. 	<ul style="list-style-type: none"> ▶ Press the ▶▶ button. ▶ Remove the mains plug from the mains socket. ▶ Wait for about 1 minute. ▶ Insert the mains plug into the mains socket again and select a new programme.
	<ul style="list-style-type: none"> ▪ If the error appears again: 	<ul style="list-style-type: none"> ▶ Note down error message in full and appliance's SN. ▶ Remove the mains plug from the mains socket. ▶ Call Customer Services.
UXX/EXX see instructions SN XXXXX XXXXXX	<ul style="list-style-type: none"> ▪ Overvoltage (U1) ▪ Undervoltage (U2) 	<ul style="list-style-type: none"> ▶ Press the ▶▶ button. ▶ Remove the mains plug from the mains socket. ▶ Wait for about 1 minute. ▶ Insert the mains plug into the mains socket again and select a new programme.
	<ul style="list-style-type: none"> ▪ If the error appears again: 	<ul style="list-style-type: none"> ▶ Remove the mains plug from the mains socket. ▶ Have an electrician check the house installation.

11.2 Other possible problems

Problem	Possible cause	Solution	
The programme takes significantly longer than indicated.	▪ Door filter and/or door filter mat are blocked.	▶ Clean door filter and/or door filter mat (see page 25).	
	▪ Front filter mat is clogged.	▶ Clean the front filter mat (see page 26).	
	▪ Very wet washing.	▶ Spin washing at a higher speed.	
	▪ The ambient temperature is too high or too low.	▶ Improve circulation and ventilation of air in room. ▶ Ensure that the temperature of the room is between 5 and 35 °C.	
No new programme can be selected.	▪ A programme was interrupted.	▶ Press the  button. ▶ Select a new programme.	
The laundry is not dry enough and the waistband of jeans is still wet.	▪ Mixed laundry load.	▶ Select a longer programme, e.g. extra dry  Or: ▶ Select  timed drying. Or: ▶ Change the level of dryness (see page 23).	
	▪ Door filter and/or door filter mat are blocked.	▶ Clean door filter and/or door filter mat (see page 25).	
	▪ Front filter mat is clogged.	▶ Clean the front filter mat (see page 26).	
	▪ Interruption in power supply.	▶ Check the mains plug, lead and fuses.	
	▪ The moisture sensor is dirty.	▶ Clean the moisture sensor (see page 26).	
	▪ The demo mode is switched on.	▶ Switch the demo mode off (see page 24).	
	The duration remaining indicator remains frozen for a longer period.	▪ Not yet reached level of dryness required.	▶ No action is necessary. The indicator will run automatically once the level of dryness is reached.
		▪ Wash load very mixed.	▶ No action needed. The indicator will run automatically in a while.
▪ Build-up of fluff in door filter.		▶ Clean the door filter (see page 25).	

Problem	Possible cause	Solution
The progress of the programme remains frozen at «Final airing» for a longer period.	<ul style="list-style-type: none"> ▪ The laundry is being cooled down. ▪ A high ambient temperature extends the cooling-down phase. 	<ul style="list-style-type: none"> ▶ No action is necessary. The laundry can be unloaded at any time as long as it is then spread out to cool down.
The appliance will not start.	<ul style="list-style-type: none"> ▪ The temperature sensor is dirty. 	<ul style="list-style-type: none"> ▶ Clean the temperature sensor (see page 27).
	<ul style="list-style-type: none"> ▪ The appliance door is open. 	<ul style="list-style-type: none"> ▶ Close the appliance door.
	<ul style="list-style-type: none"> ▪ Door filter or front filter mat are missing. 	<ul style="list-style-type: none"> ▶ Insert door filter or front filter mat and ensure it is positioned correctly.
Interruption in power supply.	<ul style="list-style-type: none"> ▪ Interruption in power supply. 	<ul style="list-style-type: none"> ▶ Insert plug into mains socket. ▶ Turn wall switch on. ▶ Check fuse or circuit breaker.
	<ul style="list-style-type: none"> ▪ Various situations in the appliance can cause this. 	<ul style="list-style-type: none"> ▶ Close the appliance door.
		<ul style="list-style-type: none"> ▶ Touch the  button. <ul style="list-style-type: none"> – The programme is resumed.
The appliance door springs open during operation.	<ul style="list-style-type: none"> ▪ Various situations in the appliance can cause this. 	<ul style="list-style-type: none"> ▶ Close the appliance door. ▶ Touch the  button. <ul style="list-style-type: none"> – The programme is resumed.
The drum is scratched and dented.	<ul style="list-style-type: none"> ▪ Scratches and dents can be caused by drying items with buttons or buckles. 	<ul style="list-style-type: none"> ▶ No remedy necessary. Scratches and dents have no impact on the drying process or the drying results.
The laundry is badly creased.	<ul style="list-style-type: none"> ▪ Too large a load. 	<ul style="list-style-type: none"> ▶ Reduce the size of the load.
	<ul style="list-style-type: none"> ▪ The washing was spun too fast in the washing machine. 	<ul style="list-style-type: none"> ▶ Switch the additional  «ReversePlus» function on (see page 12). <p>Or:</p> <ul style="list-style-type: none"> ▶ Spin the washing at a lower spin speed.
	<ul style="list-style-type: none"> ▪ The washing is tangled by the end of the programme. 	<ul style="list-style-type: none"> ▶ Switch the additional  «ReversePlus» function on (see page 12).
	<ul style="list-style-type: none"> ▪ The laundry was left in the drum too long after the programme had finished. 	<ul style="list-style-type: none"> ▶ Unload the laundry as soon as the programme ends.
	<ul style="list-style-type: none"> ▪ The values can vary according to programme, load, additional functions and user settings. 	<ul style="list-style-type: none"> ▶ Observe the user settings and additional functions.
The consumption values for EcoManagement displayed are too high.	<ul style="list-style-type: none"> ▪ System-related fluctuations cannot be ruled out. 	

Problem	Possible cause	Solution
The bed linen gets tangled into a ball.		<ul style="list-style-type: none"> ▶ Select the additional «ReversePlus» function (see page 12). Or: <ul style="list-style-type: none"> ▶ Select the «Bed linen» textile programme (see page 11).

12 Spare parts

Please give model designation, model number and type when ordering parts (see page 2).

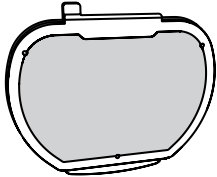

Door filter

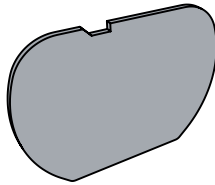

Door filter mat

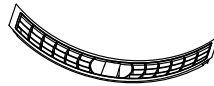

Front grille

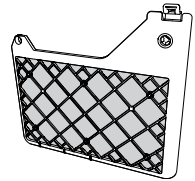

Front filter mat

13 Technical data

Dimensions

Height	85 cm
Width	59.5 cm
Depth	61 cm
Weight	65 kg
Pumping height of pump	1.2 m
Load capacity	7 kg dry washing

Ambient conditions









Permissible room temperature when appliance is in operation	5 °C to 35 °C
---	---------------

Electrical connection

The electrical connection can be found on the identification plate (see page 39).

13.1 Note for testing institutes

- ▶ The appliance must be connected to the electricity supply for at least 5 minutes before taking measurements.
- ▶ The declaration data can be determined correctly only after a run-in phase of 5 complete drying programmes with washing (automatic programme: normal dry .
- ▶ Wash the door filter each time after completing a drying programme.
- ▶ The moisture sensor of the appliance is calibrated based on average water hardness levels. To adjust the water conductivity value of the appliance according to the norm (750 µS/cm), the level of dryness must be set to «1» in the user settings (see page 23).
- ▶ Set to the standard programme according to EN 61121:

Programmes	Load capacity	Work steps
Cotton laundry, normal dry	7 kg	<ul style="list-style-type: none"> ▶ Press the  button. ▶ Press the  button. ▶ Press the  button.
Cotton laundry, iron dry	7 kg	<ul style="list-style-type: none"> ▶ Press the  button. ▶ Press the  button.
Easy-care fabric, normal dry	2.5 kg	<ul style="list-style-type: none"> ▶ Press the  button and then the  button. ▶ Press the  button.

13.2 Product fiche

In accordance with EU Regulation No. 392/2012

Brand	-	V-ZUG Ltd
The model identifier corresponds to the first 5 alphanumeric characters on the identification plate.	-	12011
Rated capacity for cotton laundry at full load	kg	7
Type of appliance	-	Condenser tumble dryer
Energy Efficiency Class	-	A++
Energy consumption of x kWh per year ¹	kWh per year	212
Type of tumble dryer	-	Automatic tumble dryer
Energy consumption of standard cotton programme at full load	kWh	1.73
Energy consumption of standard cotton programme at partial load	kWh	1.00
Power consumption of the off mode	W	0.09
Power consumption of the left-on mode	W	2.60
Duration of the left-on mode	min	10
Standard cotton programme ²		Standard programme

In accordance with EU Regulation No. 392/2012

Weighted programme time ³	min	119
Programme time for the standard cotton programme at full load	min	153
Programme time for the standard cotton programme at partial load	min	93
Condensation efficiency class ⁴	-	A
Condensation efficiency of the standard cotton programme at full load	%	93
Condensation efficiency of the standard cotton programme at partial load	%	93
Weighted condensation efficiency ⁵	%	93
Sound power level	dB	63

1 Energy consumption x kWh per year, based on 160 drying cycles of the standard cotton programme at full and partial load, and the consumption of the low-power modes. Actual energy consumption per cycle will depend on how the appliance is used.

2 The standard cotton programme to which the information in the label and the fiche relates. This programme is suitable for drying normal wet cotton laundry and is the most efficient programme in terms of energy consumption for cotton laundry.

3 The weighted programme time for the standard cotton programme at full and partial load.

4 Condensation efficiency class on a scale from G (least efficient) to A (most efficient).

5 The weighted condensation efficiency of the standard cotton programme at full and partial load.

13.3 Consumption values

Automatic programmes

The stated values for the programme duration and energy apply for the maximum stated capacity with a wash spun at around 1200 rpm (corresponds to a moisture level of approx. 60%). A higher spin speed or a smaller load reduce them by approx. 20–30%.

Programme	Load capacity kg	Remaining moisture content %	Programme duration hrs./mins.	Energy kWh
Standard programme ¹	1–7	–1 to 2	2h33	1.73
Extra dry	1–7	-4 to -1	2h55	1.97
Normal dry	1–7	–1 to 2	2h33	1.73
Iron dry	1–7	8 to 16	2h03	1.32
Damp	1–7	20 to 30	1h35	0.97

¹ Most energy-efficient programme for drying normal wet cotton laundry.

Textile programmes

The values can vary according to programme, load, additional functions, user settings, initial level of moisture in the laundry and ambient temperature.

Programme	Load capacity kg	Remaining moisture content %	Programme duration hrs./mins.	Energy kWh
Shirts	1–7 items	0 to 2	0h40	0.35
Denim	1–4	–1 to 2	1h50	1.19
Silks	1–1.5	0 to 2	0h52	0.51
Baby garments	1–5	–1 to 1	2h20	1.55

Extra programme

Programme	Load capacity kg	Remaining moisture content %	Programme duration hrs./mins.	Energy kWh
Airing	1–1.5	–	0h10	0.03

14 Drying tips

14.1 Saving energy

- Spin the washing in the washing machine at a high spin speed before tumble drying. Mechanical draining in the washing machine is much more efficient than water evaporation in the tumble dryer.
- Clean the door filter and the filter mats regularly. Dirty fluff filters block the air flow and reduce the appliance's efficiency.
- Where possible fill the drum to the maximum load capacity of the relevant programme.
- Select «EcoManagement» to find efficient programmes.

14.2 Avoiding damage

- Follow the fabric care symbols on garment labels.
- For drying, it is recommended that tumble dryer sheets or other fabric care solutions not be used.
- Remove foreign objects and larger parts made of metal or hard plastic (e.g. buckles, stones, detergent dosing aids) before tumble drying. These can dent the drum.
- Fasten hook and eye fasteners and zips. These can damage the laundry and the drum.
- Fasten cloth belts, apron ties and duvet and pillow cases to avoid them getting tangled up.

15 Disposal

15.1 Packaging



Never allow children to play with packaging material due to the danger of injury or suffocation. Store the packaging material in a safe location or dispose of it in an environmentally-friendly way.

15.2 Safety

Render the appliance unusable to prevent accidents caused by improper use (e.g. through children playing):

- ▶ Disconnect the appliance from the mains. With a fixed appliance, this is to be carried out by a qualified electrician. Then cut the mains cable off flush with the appliance.
- ▶ Remove or disable the lock on the appliance door.

15.3 Disposal



-  The «crossed out wheeled bin» symbol requires the separate collection of waste electrical and electronic equipment (WEEE). Such equipment can contain hazardous, environmentally harmful materials.
- These appliances are to be handed over to a designated collection point for the recycling of electrical and electronic equipment and must not be disposed of with unsorted household waste. And in this way, you will be helping to protect resources and the environment.
- For more information, please contact the local authorities.

15.4 Note on heat pump

This appliance is CFC-free. It contains fluorinated greenhouse gas covered by the Kyoto Protocol.

Heat pump	Hermetically closed
Greenhouse gas	R134a
Filling quantity [kg]	0.270
GWP [(kg CO ₂)/(kg greenhouse gas)]	1430
Total GWP [t CO ₂]	0.386

Index

A	
Additional functions.....	12
Starting.....	16
Airing	
Extra programmes.....	12
Appliance disposal.....	35
Automatic programmes.....	10, 11
Consumption values.....	33
Starting.....	14
B	
Baby garments	
Textile programmes.....	12
Background image.....	23
Basket programme	
Extra programmes.....	12
Bed linen	
ReversePlus.....	12
Brightness.....	22
Button tone.....	22
C	
Calculating time remaining.....	13
Childproof lock.....	23
Coloureds	
Textile programmes.....	11
D	
Delayed start.....	12
Starting.....	16
Demo mode.....	24
Denim	
Textile programmes.....	11
Determining load.....	13
Disposal.....	35
Drum illumination.....	10
Duration remaining indicator.....	29
E	
EcoManagement.....	10, 13
Displays.....	18
Switching on.....	23
Ending	
Programme.....	17
Energy consumption.....	13
Energy-efficient drying	
Delayed start.....	12
Even drying	
ReversePlus.....	12
Extra programmes.....	10, 12
Consumption values.....	34
Starting.....	15
F	
Factory settings.....	24
Favourites.....	10
Changing.....	20
Defining.....	19
Deleting.....	20
Starting.....	20
Final airing.....	30
G	
Gloves	
Basket programme.....	12
H	
Hats	
Basket programme.....	12
Heat pump.....	35
I	
Interrupting	
Programme.....	17
L	
Language.....	22
Level of dryness.....	23
Long programme duration.....	29
M	
Malfunctions.....	27
Model designation.....	2
Model number.....	2
N	
Notes.....	38
O	
Open appliance door.....	14
P	
Pause.....	10
Problems.....	27
Programme	
Changing.....	16
Ending before time.....	10, 17
Interrupting.....	10, 17
Starting.....	10, 14, 15
Q	
Queries.....	39
R	
ReversePlus.....	12, 23

Risk of tangling	
ReversePlus.....	12
S	
Safety precautions	
General.....	5
Safety warnings	
Appliance-specific	6
Saving energy.....	34
EcoManagement.....	13
Service & Support.....	39
Service agreement.....	39
Shirts	
Textile programmes	11
Silks	
Textile programmes	11
Soft toys	
Basket programme.....	12
Spare parts	31
Standard programme.....	10, 12
Starting.....	15
Symbols.....	5
T	
Table linen	
Damp	11
Textile programmes.....	10, 11
Consumption values	34
Starting.....	15
Timed drying.....	10, 11, 15
Trainers	
Basket programme.....	12
T-shirts	
Normal dry.....	11
Tumble dry, low heat	
Baby garments.....	12
Easy care	12
Shirts	11
Silks.....	11
Type.....	2
U	
Underwear	
Normal dry.....	11
Using for the first time.....	9
V	
Validity.....	2
Viewing angle	22
V-ZUG App.....	21
V-ZUG-Home.....	10, 23
W	
WLAN connection	21

16 Notes

17 Service & Support



The «Trouble-shooting» section gives you valuable tips on how to deal with minor malfunctions yourself, saving you the time and trouble of calling out a service technician and any cost that goes along with it.

Information on the V-ZUG warranty can be found at www.vzug.com →Service →Warranty information. Please read this information carefully.

Please register your V-ZUG appliance straightaway:

- online at www.vzug.com →Service →Online warranty registration or
- using the enclosed registration card.

This will allow you to take advantage of the best possible support in the event of a fault in the appliance during the guarantee period. You will require the serial number (SN) and appliance designation to register your appliance. You will find them on the identification plate of your appliance.

My appliance information:

SN: _____ **Appliance:** _____

Please have this appliance information to hand when contacting V-ZUG. Thank you.

Identification plate

- ▶ Open the appliance door.
 - The identification plate is located bottom right.



The SN can also be retrieved as follows:

- ▶ Hold the **▶▶** button depressed until «Settings – SN 12011 000123» appears in the TouchDisplay.

Your repair order

Call the free service number 0800 850 850 to contact your nearest V-ZUG service centre. You can arrange an on-site visit by us by phone if you wish.

General queries, accessories and service agreement

V-ZUG will be happy to help you with any general administrative or technical queries, to accept your orders for accessories and spare parts and to inform you about our progressive service agreements. You can contact us by calling tel. +41 58 767 67 67 or by going to our website at www.vzug.com.

Quick instructions

Please first read the safety precautions in the operating instructions!

Starting programme	When programme has finished
<ul style="list-style-type: none">▶ Open the appliance door.▶ Check door filter.▶ Load laundry.▶ Close the appliance door.▶ Select programme and any additional functions (if required).▶ Press the  button. Programme starts.	<ul style="list-style-type: none">▶ When «0h00» appears in the display, unload the dry laundry.▶ Clean the door filter.▶ Close the appliance door.



1057819-R03

